



CE EMC Test Report

Issued date: Jul. 17, 2024

Project No.: 24Q050601

Product : Edge AI Computing System

Model : EAC-6200

Series Model : EAC-6000 Series, EAC-6XXXXXXXXXXXXXXXXXXXX ("X" can be 0-9, A-Z, - or blank for marketing purpose)

Applicant : Vecow Co., Ltd

Address : 3F, No. 10, Jiankang Rd., Zhonghe Dist., New Taipei City 23586, Taiwan

Report No: WD-EE-R-240206-B0

According to

EN 50121-1: 2017

EN 50121-3-2: 2016

EN 50155:2021, Clause 13.4.9

EN 61000-3-2:2014, Class A

EN IEC 61000-3-2:2019 + A1:2021, Class A

EN 61000-3-3: 2013 + A1:2019 + A2:2021

EN 61000-4-2: 2009

EN IEC 61000-4-3: 2020

EN 61000-4-4: 2012

EN 61000-4-5: 2014 + A1: 2017

EN 61000-4-6: 2014 + AC: 2015

BS EN 50121-1: 2017

BS EN 50121-3-2: 2016

BS EN 50155:2021, Clause 13.4.9

BS EN 61000-3-2:2014, Class A

BS EN IEC 61000-3-2:2019 + A1:2021, Class A

BS EN 61000-3-3: 2013 + A1:2019 + A2:2021

BS EN 61000-4-2: 2009

BS EN IEC 61000-4-3: 2020

BS EN 61000-4-4: 2012

BS EN 61000-4-5: 2014 + A1: 2017

BS EN 61000-4-6: 2014 + AC: 2015

Authorized Signatory :  / Ken Huang

Wendell Industrial Co., Ltd
Wendell EMC & RF Laboratory

Add: 5F-1, No. 188, Baoqiao Road, Xindian District, New Taipei City 23145, Taiwan R.O.C.



Table of Contents

1	Certification	6
1.1	Summary of Test Result.....	7
2	Test Configuration of Equipment Under Test	8
2.1	Test Facility.....	8
2.2	Measurement Uncertainty	9
2.2.1	Conducted Emission test.....	9
2.2.2	Radiated Emission test.....	9
3	General Information.....	10
3.1	Description of EUT.....	10
3.2	Description of Test Modes.....	11
3.3	EUT Operating Condition	11
3.4	Description of Support Unit	12
3.5	Configuration of System Under Test.....	13
4	Emission Test.....	14
4.1	Conducted Emission Measurement	14
4.1.1	Limit of Conducted Emission Measurement	14
4.1.2	Test Instrument	15
4.1.3	Test Procedure.....	16
4.1.4	Deviation from Test Standard	16
4.1.5	Test Setup.....	17
4.1.6	Test Result	18
4.1.7	Photographs of Test Configuration	20
4.2	Radiated Emission Measurement	21
4.2.1	Limits of Radiated Emission Measurement	21
4.2.2	Test Instrument	22
4.2.3	Test Procedure.....	23
4.2.4	Deviation from Test Standard	23
4.2.5	Test Setup.....	24
4.2.6	Test Result	27
4.2.7	Photographs of Test Configuration	31
4.3	Harmonics Current Measurement.....	33
4.3.1	Limits of Harmonics Current Measurement	33
4.3.2	Test Instrument	33
4.3.3	Test Procedure.....	34
4.3.4	Deviation from Test Standard	35
4.3.5	Test Setup.....	35
4.3.6	Test Result	36
4.3.7	Photographs of Test Configuration	37
4.4	Voltage Fluctuation and Flicker Measurement	38
4.4.1	Limit for Voltage Function and Flicker Measurement	38
4.4.2	Test Instrument	38
4.4.3	Test Procedure.....	38
4.4.4	Deviation from Test Standard	38
4.4.5	Test Setup.....	39



4.4.6	Test Result	40
4.4.7	Photographs of Test Configuration	41
5	Immunity Test	42
5.1	Standard Description	42
5.2	Performance Criteria	43
5.3	Electrostatic Discharge (ESD)	44
5.3.1	Test Specification.....	44
5.3.2	Test Instrument	44
5.3.3	Test Procedure.....	45
5.3.4	Deviation from Test Standard	46
5.3.5	Test Setup.....	46
5.3.6	Test Result	48
5.3.7	Photographs of Test Configuration	53
5.4	Radiated, Radio-frequency, Electromagnetic Field Immunity Test (RS).....	54
5.4.1	Test Specification.....	54
5.4.2	Test Instrument	55
5.4.3	Test Procedure.....	56
5.4.4	Deviation from Test Standard	56
5.4.5	Test Setup.....	57
5.4.6	Test Result	58
5.4.7	Photographs of Test Configuration	60
5.5	Electrical Fast Transient Immunity Test (EFT).....	61
5.5.1	Test Specification.....	61
5.5.2	Test Instrument	61
5.5.3	Test Procedure.....	62
5.5.4	Deviation from Test Standard	62
5.5.5	Test Setup.....	63
5.5.6	Test Result	64
5.5.7	Photographs of Test Configuration	65
5.6	Surge Immunity Test.....	67
5.6.1	Test Specification.....	67
5.6.2	Test Instrument	67
5.6.3	Test Procedure.....	68
5.6.4	Deviation from Test Standard	68
5.6.5	Test Setup.....	69
5.6.6	Test Result	70
5.6.7	Photographs of Test Configuration	71
5.7	Radio-frequency common mode (CS).....	72
5.7.1	Test Specification.....	72
5.7.2	Test Instrument	72
5.7.3	Test Procedure.....	73
5.7.4	Deviation from Test Standard	74
5.7.5	Test Setup.....	74
5.7.6	Test Result	75
5.7.7	Photographs of Test Configuration	76



History of this test report

Report No.	Issue date	Description
WD-EE-R-240206-B0	Jul. 17, 2024	Initial Issue

Declaration

This report is for your exclusive use. Any copying or replication of this report to or for any other person or entity, or use of our name or trademark, is permitted only with our prior written permission. This report sets forth our findings solely with respect to the test samples identified herein. The results set forth in this report are not indicative or representative of the quality or characteristics of the lot from which a test sample was taken or any similar or identical product unless specifically and expressly noted. Our report includes all of the tests requested by you and the results thereof based upon the information that you provided to us.



History of supplementary report

Report No.	Issue date	Description
WD-EE-R-240206-B0	Jul. 17, 2024	Original report

Declaration

This report is for your exclusive use. Any copying or replication of this report to or for any other person or entity, or use of our name or trademark, is permitted only with our prior written permission. This report sets forth our findings solely with respect to the test samples identified herein. The results set forth in this report are not indicative or representative of the quality or characteristics of the lot from which a test sample was taken or any similar or identical product unless specifically and expressly noted. Our report includes all of the tests requested by you and the results thereof based upon the information that you provided to us.



1 Certification

Product: Edge AI Computing System
Brand Name: Vecow
Model: EAC-6200
Series Model: EAC-6000 Series, EAC-6XXXXXXXXXXXXXXXXXXXXXXX ("X" can be 0-9, A-Z, - or blank for marketing purpose)
Applicant: Vecow Co., Ltd
Tested: May 31 ~ Jul. 11, 2024
Standard: **EN 50121-1: 2017**
EN 50121-3-2: 2016
EN 50155:2021, Clause 13.4.9
EN 61000-3-2:2014, Class A
EN IEC 61000-3-2:2019 + A1:2021, Class A
EN 61000-3-3: 2013 + A1:2019 + A2:2021
EN 61000-4-2: 2009
EN IEC 61000-4-3: 2020
EN 61000-4-4: 2012
EN 61000-4-5: 2014 + A1: 2017
EN 61000-4-6: 2014 + AC: 2015
BS EN 50121-1: 2017
BS EN 50121-3-2: 2016
BS EN 50155:2021, Clause 13.4.9
BS EN 61000-3-2:2014, Class A
BS EN IEC 61000-3-2:2019 + A1:2021, Class A
BS EN 61000-3-3: 2013 + A1:2019 + A2:2021
BS EN 61000-4-2: 2009
BS EN IEC 61000-4-3: 2020
BS EN 61000-4-4: 2012
BS EN 61000-4-5: 2014 + A1: 2017
BS EN 61000-4-6: 2014 + AC: 2015

The above equipment (Model: EAC-6200) has been tested by **Wendell EMC & RF Laboratory**, and found compliance with the requirement of the above standards. The test record, data evaluation and Equipment Under Test (EUT) configurations represented herein are true and accurate accounts of the measurements of the sample's EMC characteristics under the conditions specified in this report.

Please note that the measurement uncertainty are provided for informational purpose only and are not used in determining the Pass/Fail results.

1.1 Summary of Test Result

The EUT has been tested according to the following specifications:

Emission			
Basic Standard	Test Item	Result	Remark
EN 55016-2-1	Conducted disturbance at mains terminals	Pass	Meets the requirements
EN IEC 61000-6-4	Radiated disturbance	Pass	Meets the requirements
EN 61000-3-2	Harmonic current emissions	Pass	The power consumption of EUT is less than 75W and no limits apply
EN 61000-3-3	Voltage fluctuations and flicker	Pass	Meets the requirements

Immunity			
Basic Standard	Test Item	Result	Remark
EN 61000-4-2	Electrostatic discharges (ESD)	Pass	Meets the requirements of Performance Criterion B
EN IEC 61000-4-3	Radiated, Radio-frequency, Electromagnetic field immunity test (RS)	Pass	Meets the requirements of Performance Criterion A
EN 61000-4-4	Electrical fast transient immunity test (EFT)	Pass	Meets the requirements of Performance Criterion A
EN 61000-4-5	Surges immunity test	Pass	Meets the requirements of Performance Criterion A
EN 61000-4-6	Radio-frequency common mode (CS)	Pass	Meets the requirements of Performance Criterion A

Note: Test record contained in the referenced test report relate only to the EUT sample and test item.



2 Test Configuration of Equipment Under Test

2.1 Test Facility

Conducted disturbance at mains terminals, Harmonics, Flicker, ESD, EFT, Surge and CS Tests

W01: 5F-1, No.188, Baoqiao Rd., Xindian Dist., New Taipei City 23145, Taiwan R.O.C.

RS Test

W05: 1F-7, No.188, Baoqiao Rd., Xindian Dist., New Taipei City 23145, Taiwan R.O.C.

Conducted disturbance at mains terminals and Radiated emission (9*6*6 Chamber) Tests

W08: No.119, Wugong 3rd Rd., Wugu Dist., New Taipei City 248, Taiwan (R.O.C)

ACCREDITATIONS

The laboratories are accredited and approved by the TAF according to ISO/EN 17025.

2.2 Measurement Uncertainty

The measurement instrumentation uncertainty is evaluated according to CISPR 16-4-2.

This uncertainty represents an expanded uncertainty expressed at approximately the 95% confidence level using a coverage factor of $k=2$.

Wendell EMC & RF Laboratory U_{lab} is less than U_{cispr} , therefore compliance or non-compliance with a disturbance limit shall be determined in the following manner.

- compliance is deemed to occur if no measured disturbance level exceeds the disturbance limit;
- non-compliance is deemed to occur if any measured disturbance level exceeds the disturbance limit.

Please note that the measurement uncertainty (U_{lab}) is provided for informational purpose only and is not used in determining the Pass/Fail results.

2.2.1 Conducted Emission test

Test Site	Measurement Freq. Range	dB (U_{lab})	Note
W01-CE	150 kHz ~ 30 MHz	2.75	N/A
W08-CE	150 kHz ~ 30 MHz	2.76	N/A

2.2.2 Radiated Emission test

Test Site	Measurement Freq. Range	Ant	dB (U_{lab})	Note
W08-966-1	30 MHz ~ 200 MHz	V	3.78	N/A
	30 MHz ~ 200 MHz	H	2.69	N/A
	200 MHz ~ 1000 MHz	V	4.91	N/A
	200 MHz ~ 1000 MHz	H	3.40	N/A
	1 GHz ~ 6 GHz	V	4.48	N/A
	1 GHz ~ 6 GHz	H	4.33	N/A



3 General Information

3.1 Description of EUT

Product	Edge AI Computing System
Brand	Vecow
Model	EAC-6200
Series Model	EAC-6000 Series, EAC-6XXXXXXXXXXXXXXXXXXXXXXX ("X" can be 0-9, A-Z, - or blank for marketing purpose)
Applicant	Vecow Co., Ltd
Received Date	May 16, 2024
EUT Power Rating	24Vdc (from adapter)
Model Differences	The models are electrically identical, different models no. are for marketing purpose. The series model information is provided by client.
Operating System	Ubuntu 20.04.5 LTS, Burnintest
Data Cable Supplied	N/A
Accessory Device	N/A
I/O Port	Please refer to the User's Manual

Note:

- The EUT uses the follow adapter:

Adapter (support unit only)	
Brand	FSP
Model	FSP120-AAAN2
Input Power	100-240Vac, 1.8A, 50-60Hz
Output Power	24Vdc, 5A
Power line	Input: 1.2m non-shielded cable Output: 1.8m non-shielded cable

- The EUT contains following MB, SSD & GPU board.

Item	Brand	Model	Spec.	Qty.
Main Board	-	EAC-6000	Rev. C	1
M.2 SSDs	Transcend	TS1TMTE712A-I	1TB	1

GPU board:

Item	Spec.
SoM	NVIDIA® Jetson Orin NX 16GB Module
CPU	8-core Cortex-A78AE Armv8.2 (64-bit) CPU
GPU	1024-core Ampere™ GPU with 32 Tensor Cores
RAM	16 GB 128-bit LPDDR5 DRAM

- The EUT's highest operating frequency is 1651MHz. Therefore the radiated emission is tested up to 6GHz.

3.2 Description of Test Modes

Test results are presented in the report as below.

Test Mode	Test Condition
Conducted emission test	
-	Adapter mode
Radiated emission 30MHz ~ 1GHz test	
-	Adapter mode
Radiated emission above 1GHz test	
-	Adapter mode
Harmonics, Flicker and Immunity test	
-	Adapter mode

3.3 EUT Operating Condition

- a. Placed the EUT on the test table.
- b. Prepare PC to act as a communication partner and placed it outside of testing area.
- c. The EUT was connected to the PC with LAN cable.
- d. The communication partner sent data to EUT by command "ping" via LAN.
- e. The IPCAM sent signal to EUT through PoE supply LAN cable.
- f. The EUT read and write data with Internal SSD & USB flash.
- g. The EUT run test program "BurnIN.exe" to enable all functions.
- h. The EUT sent "Color Bar ITU-R.BT471-1" signal to monitor and displayed on screen.



3.4 Description of Support Unit

The EUT has been conducted testing with other necessary accessories or support units.

Item	Equipment	Brand	Model No.	Serial No.	FCC ID	Data Cable	Power Cable	Remark
1	Desktop PC	DELL	D19M	N/A	PPD-QCN FA335	20m CAT.5E non-shielded RJ45 cable	1.8m non-shielded cable	-
2	Desktop PC	DELL	D13M	H6K10 A00	FCC DoC Approved	20m CAT.5E non-shielded RJ45 cable	1.8m non-shielded cable	-
3	4K monitor	HP	HP 27f 4k Display	3CM01935T F	FCC DoC Approved	1.5m shielded HDMI cable with 2 cores	AC: 1.8m non-shielded cable DC: 1.4m non-shielded cable with 1 core	-
4	Keyboard	DELL	KB216t	CN-0W33XP -L0300-7C1- 15UP	FCC DoC Approved	1.5m non-shielded cable	N/A	-
5	Mouse	Logitech	M-U0026	HS726HB	FCC DoC Approved	2m non-shielded cable	N/A	-
6	USB flash	SANDISK	32GB	N/A	FCC DoC Approved	N/A	N/A	-
7	Grounding wire	N/A	N/A	N/A	N/A	1m non-shielded cable	N/A	-
8	CAN bus test device	N/A	N/A	N/A	N/A	0.3m non-shielded CAN bus cable	N/A	Supplied by client
9	IP camera (x4)	Messoa	MBL030A-O RZ0310	N/A	N/A	1m CAT.7 shielded RJ45 cable	N/A	Supplied by client
10	RS232 terminator (x4)	N/A	N/A	N/A	N/A	N/A	N/A	Supplied by client

- Note:**
1. The core(s) is(are) originally attached to the cable(s).
 2. Item 1-2 acted as communication partners to transfer data.

3.5 Configuration of System Under Test

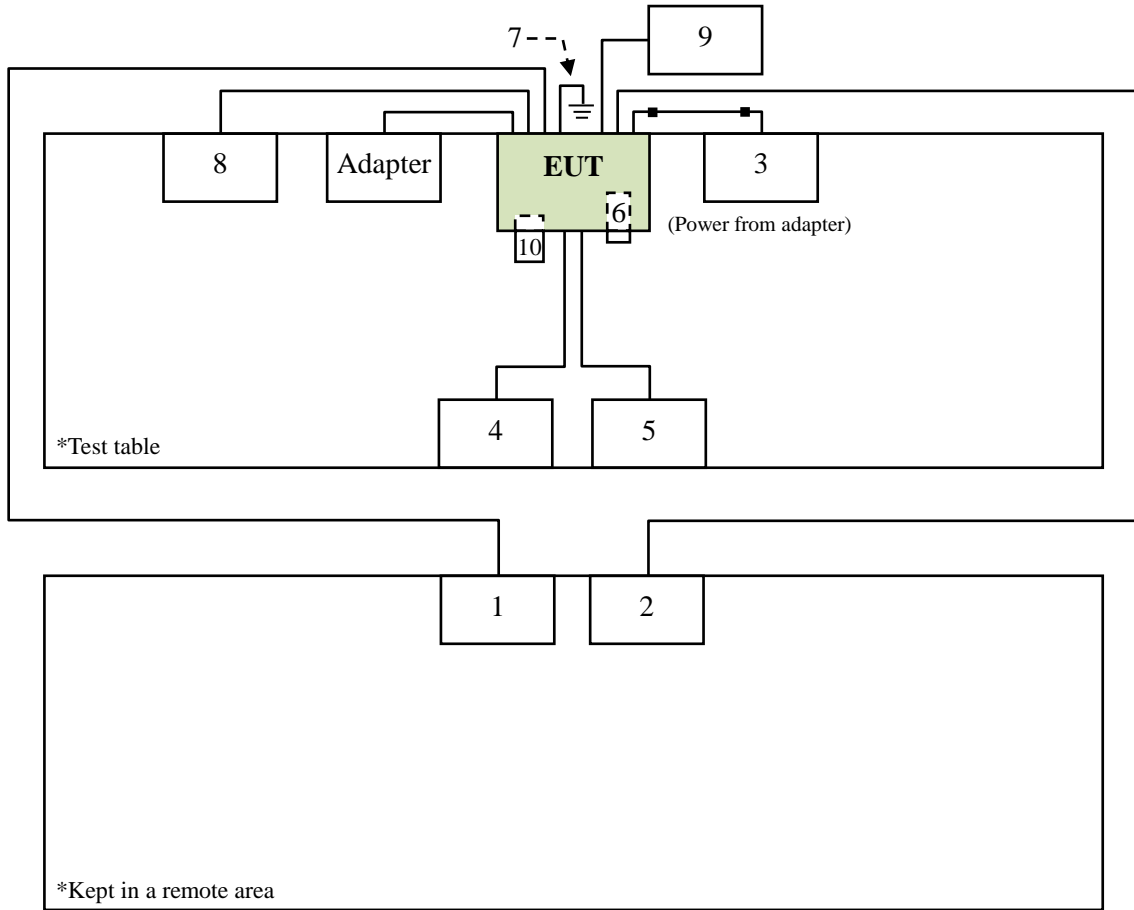

4 Emission Test

4.1 Conducted Emission Measurement

4.1.1 Limit of Conducted Emission Measurement

Frequency (MHz)	EN 50121-3-2
	Quasi-peak (dB μ V)
0.15 to 0.5	99
0.5 to 30.0	93

- Note:**
1. The lower limit shall apply at the transition frequencies.
 2. Detector function in the form: QP = Quasi Peak
 3. The test result calculated as following:
Measurement Value = Reading Level + Correct Factor
Correction Factor = Insertion loss of LISN + Cable loss + Transient Limiter (If use)
Margin Level = Measurement Value – Limit Value



4.1.2 Test Instrument

Test Site: W01-CE					
Item	Equipment	Manufacturer	Model	Meter No.	Calibration Date
1	TWO-LINE V-NETWORK	R&S	ENV216	CT-1-025-1	Jun. 05, 2024
2	Pulse limiter	R&S	ESH3-Z2	CT-2-015	Jun. 06, 2024
3	EMI Test Receiver	R&S	ESCI	CT-1-024	Jun. 06, 2024
4	Artificial Mains Network (AMN)	SCHWARZBECK	NSLK 8127	CT-1-104-1	Jun. 06, 2024
5	RF Cable	MVE	200200.400LL .500A	CT-9-101	Jun. 06, 2024
6	50ohm Termination	N/A	N/A	CT-1-065-1	May 30, 2024
7	Measurement Software	EZ-EMC	Ver: EMC-CON 3A1	CT-3-012	No calibration request

Note: 1. The calibration interval of the above test instruments is 12 months.

Test Site: W08-CE					
Item	Equipment	Manufacturer	Model	Meter No.	Calibration Date
1	TWO-LINE V-NETWORK	R&S	ENV216	CT-1-025-2	Jun. 20, 2024
2	RF Cable	EMCI	EMCCFD300-BM-BM-5000	CT-1-107-2	Jun. 24, 2024
3	EMI Test Receiver	R&S	ESR3	CT-1-103	Jun. 20, 2024
4	Artificial Mains Network (AMN)	SCHWARZBECK	NSLK 8127 RC	CT-1-104-1R C	Jun. 20, 2024
5	Transient Limiter	Electro-Metrics	EM-7600	CT-1-026	Jun. 24, 2024
6	50ohm Termination	N/A	N/A	CT-1-109-1	Jun. 20, 2024
7	Measurement Software	EZ-EMC	Ver: EMC-CON 3A1	CT-3-012	No calibration request

Note: 1. The calibration interval of the above test instruments is 12 months.

4.1.3 Test Procedure

- a. The table-top EUT was placed 0.8 meter height wooden table from the horizontal ground plane with EUT being connected to power source through a line impedance stabilization network (LISN). The floor-standing EUT was placed insulation support unit from the horizontal ground plane. The LISN at least be 80 cm from nearest chassis of EUT.
- b. The line impedance stabilization network (LISN) provides 50 ohm/50uH of coupling impedance for the measuring instrument. All other support equipments powered from additional LISN(s).
- c. Interrelating cables that hang closer than 40 cm to the ground plane shall be folded back and forth in the center forming a bundle. All I/O cables were positioned to simulate typical usage.
- d. All I/O cables that are not connected to a peripheral shall be bundle in the center. The end of the cable may be terminated, if required, using the correct terminating impedance. The overall length shall not exceed 1 m.
- e. The EMI test receiver connected to LISN powering the EUT. The actual test configuration, please refer to EUT test photos.
- f. The receiver scanned from 150kHz to 30MHz for emissions in each of test modes. A scan was taken on both power lines, Line and Neutral, recording at least six highest emissions.
- g. The EUT and cable configuration of the above highest emission levels were recorded. The test data of the worst case was recorded.

4.1.4 Deviation from Test Standard

No deviation



4.1.6 Test Result

Test Voltage	230Vac, 50Hz	Frequency Range	0.15-30 MHz
Environmental Conditions	22°C, 50% RH	6dB Bandwidth	9 kHz
Test Date	2024/07/05	Phase	L
Tested by	Guanwei Liao	Test Site	W01-CE

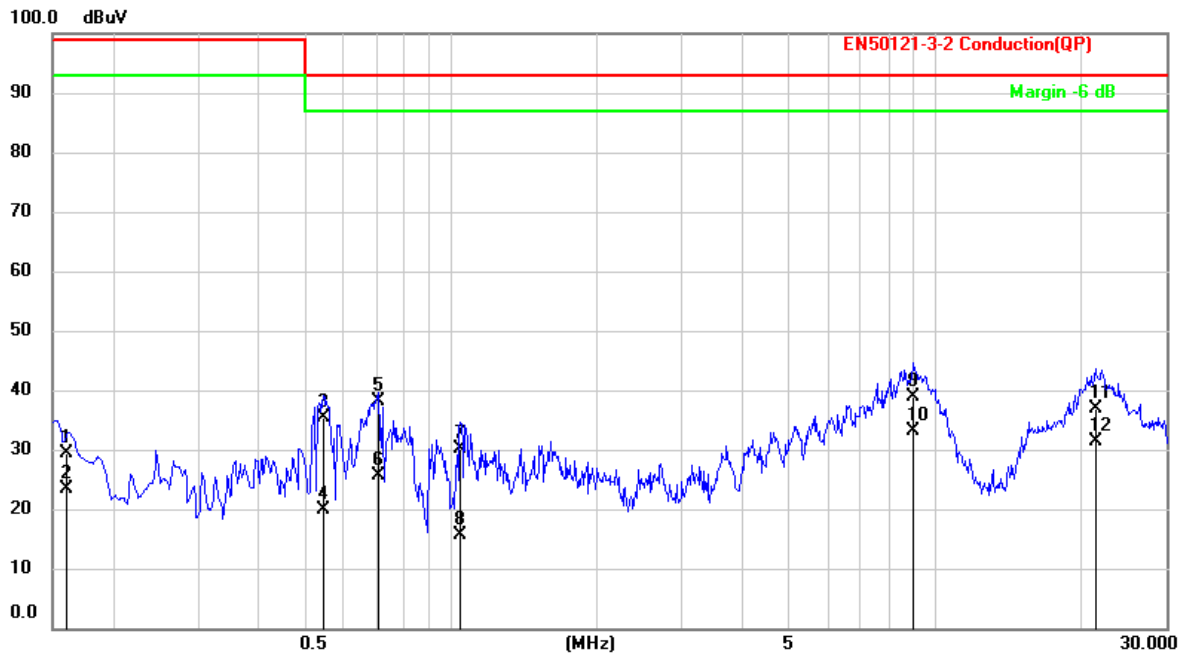

No.	Frequency (MHz)	Reading Level (dBμV)	Correct Factor (dB)	Measurement (dBμV)	Limit (dBμV)	Margin (dB)	Detector
1	0.1601	19.49	9.91	29.40	99.00	-69.60	QP
2	0.1601	13.53	9.91	23.44	99.00	-75.56	AVG
3	0.5460	25.57	9.93	35.50	93.00	-57.50	QP
4	0.5460	9.86	9.93	19.79	93.00	-73.21	AVG
5	0.7062	28.16	9.94	38.10	93.00	-54.90	QP
6	0.7062	15.58	9.94	25.52	93.00	-67.48	AVG
7	1.0537	20.28	9.95	30.23	93.00	-62.77	QP
8	1.0537	5.74	9.95	15.69	93.00	-77.31	AVG
9	9.0262	28.70	10.14	38.84	93.00	-54.16	QP
10	9.0262	23.01	10.14	33.15	93.00	-59.85	AVG
11	21.4846	26.47	10.30	36.77	93.00	-56.23	QP
12	21.4846	20.97	10.30	31.27	93.00	-61.73	AVG

Remark: 1. QP = Quasi Peak, AVG = Average
 2. Correction Factor = Insertion loss of LISN + Cable loss
 3. Measurement Value = Reading Level + Correct Factor
 4. Margin Level = Measurement Value - Limit Value



Test Voltage	230Vac, 50Hz	Frequency Range	0.15-30 MHz
Environmental Conditions	22°C, 50% RH	6dB Bandwidth	9 kHz
Test Date	2024/07/05	Phase	N
Tested by	Guanwei Liao	Test Site	W01-CE

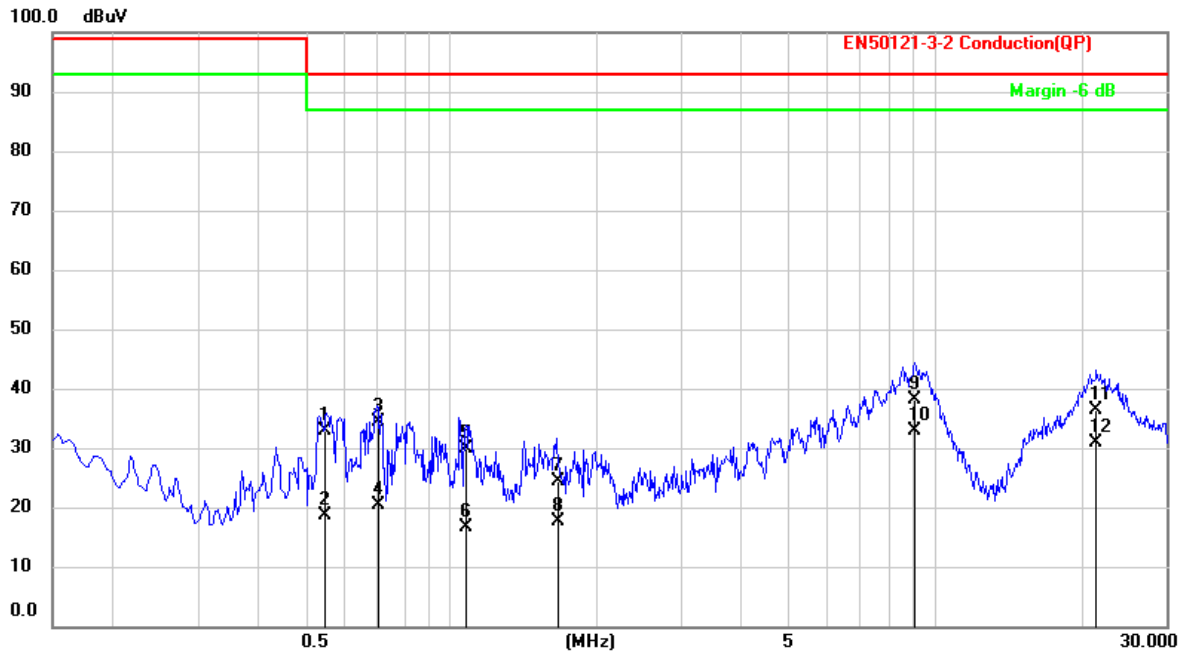

No.	Frequency (MHz)	Reading Level (dBμV)	Correct Factor (dB)	Measurement (dBμV)	Limit (dBμV)	Margin (dB)	Detector
1	0.5497	22.91	9.91	32.82	93.00	-60.18	QP
2	0.5497	8.70	9.91	18.61	93.00	-74.39	AVG
3	0.7063	24.57	9.92	34.49	93.00	-58.51	QP
4	0.7063	10.57	9.92	20.49	93.00	-72.51	AVG
5	1.0712	19.92	9.93	29.85	93.00	-63.15	QP
6	1.0712	6.76	9.93	16.69	93.00	-76.31	AVG
7	1.6669	14.37	9.95	24.32	93.00	-68.68	QP
8	1.6669	7.76	9.95	17.71	93.00	-75.29	AVG
9	9.1171	27.96	10.14	38.10	93.00	-54.90	QP
10	9.1171	22.63	10.14	32.77	93.00	-60.23	AVG
11	21.6084	26.14	10.29	36.43	93.00	-56.57	QP
12	21.6084	20.68	10.29	30.97	93.00	-62.03	AVG

Remark: 1. QP = Quasi Peak, AVG = Average
 2. Correction Factor = Insertion loss of LISN + Cable loss
 3. Measurement Value = Reading Level + Correct Factor
 4. Margin Level = Measurement Value - Limit Value

4.1.7 Photographs of Test Configuration

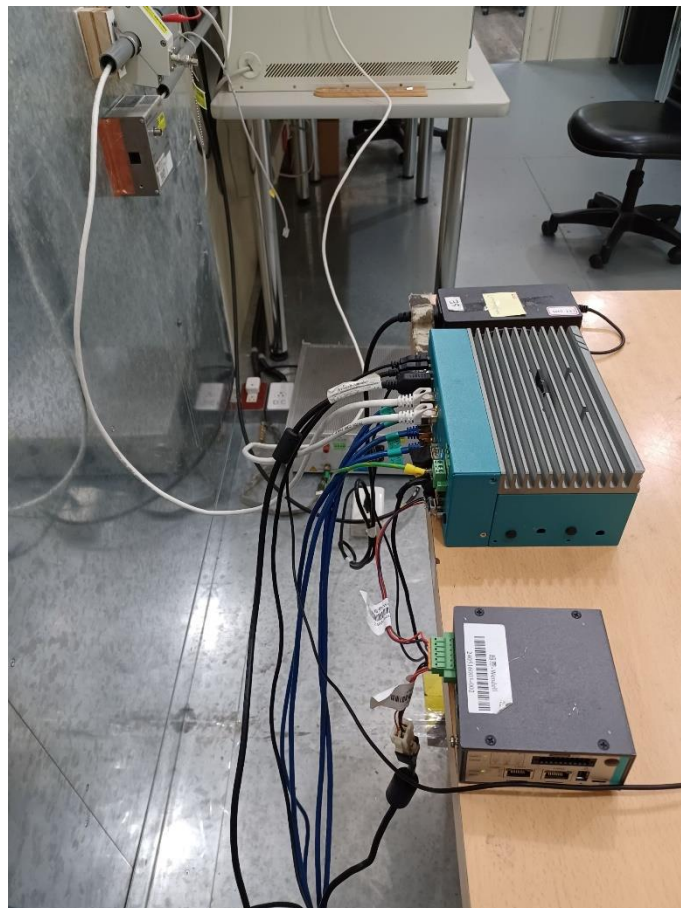

4.2 Radiated Emission Measurement

4.2.1 Limits of Radiated Emission Measurement

Radiated Frequency range 30 MHz to 1000 MHz

Frequency (MHz)	EN 50121-3-2 (at 3m)	
	Quasi Peak (dB μ V/m)	
30 to 230	50	
230 to 1000	57	

Note: 1. The lower limit shall apply at the transition frequency.

Radiated Frequency range above 1 GHz

Frequency (GHz)	EN 50121-3-2 (at 3m)	
	Average (dB μ V/m)	Peak (dB μ V/m)
1 to 3	56	76
3 to 6	60	80

- Note:**
- The lower limit shall apply at the transition frequency.
 - Detector function in the form: PK = Peak, QP = Quasi Peak, AV = Average
 - The test result calculated as following:
 Measurement Value = Reading Level + Correct Factor
 Correction Factor = Antenna factor + Cable loss (Antenna to preamplifier) - preamplifier Gain
 + Cable loss (preamplifier to receiver)
 Margin Level = Measurement Value - Limit Value
 - Maximum internal signal source is defined as the maximum frequency of the device under test, or EUT highest frequency tuning of the operation or in the production or use of the device under test.
 - If the highest internal frequency of the EUT is less than 108MHz, the measurement shall only be made up to 1GHz.
 - If the highest internal frequency of the EUT is between 108MHz and 500MHz, the measurement shall only be made up to 2GHz.
 - If the highest internal frequency of the EUT is between 500MHz and 1GHz, the measurement shall only be made up to 5GHz.
 - If the highest internal frequency of the EUT is above 1 GHz, the measurement shall be made up to 6 GHz. Where the highest internal frequency is not known, tests shall be performed up to 6GHz.



4.2.2 Test Instrument

Test Site: W08-966-1					
Item	Equipment	Manufacturer	Model	Meter No.	Calibration Date
1	Horn Antenna	Schwarzbeck	BBHA 9120D	CT-9-031	Jul. 31, 2023
2	Horn Antenna	Schwarzbeck	BBHA 9170	CT-9-032	Aug. 21, 2023
3	TRILOG Broadband Antenna with 6 dB Attenuator	Schwarzbeck & MVE	VULB 9168 & MVE2251-06	CT-1-096-1	May 06, 2024
4	Spectrum Analyzer	Agilent	E4407B	CT-1-003(1)	Aug. 02, 2023
5	EXA Signal Analyzer	Keysight	N9010A	CT-1-093	Aug. 18, 2023
6	EMI Test Receiver	Keysight	N9038A	CT-9-007	Aug. 02, 2023
7	Preamplifier	EM	EM 330	CT-9-024	Aug. 03, 2023
8	Preamplifier	SGH & MCL	SGH118 & BW-S15W2+	CT-9-071	Aug. 03, 2023
9	Preamplifier	EMCI	EMC184045SE	CT-9-013	Aug. 22, 2023
10	Test Cable	EMCI	EMCCFD400-NM-NM-1000	CT-1-132	Aug. 03, 2023
11	Test Cable	PEWC	CFD400NL-LW-NM-NM-3000	CT-1-141	Aug. 03, 2023
12	Test Cable	EMCI	EMCCFD400-NM-NM-15000	CT-1-133	Aug. 03, 2023
13	Test Cable	EMCI	EMC104-SM-35M-600	CT-1-134	Aug. 03, 2023
14	Test Cable	MVE	280280.LL266.1400	CT-9-072	Aug. 03, 2023
15	Test Cable	EMCI	EMC102-KM-KM-600	CT-1-136	Aug. 22, 2023
16	Measurement Software	EZ-EMC	Ver :WD-03A1-1	CT-3-012	No calibration request

Note: 1. The calibration interval of the above test instruments is 12 months.

4.2.3 Test Procedure

- a. The table-top EUT was placed on the top of a turntable 0.8 meters above the ground at 3 m 966 chamber. The floor-standing EUT was placed insulation support unit from the horizontal ground plane. The table was rotated 360 degrees to determine the position of the high radiation emissions.
- b. The height of the test antenna shall vary between 1 m to 4 m. Both vertical and horizontal polarizations of the antenna were set to make the measurement.
- c. The EUT was set up as per the test configuration to simulate typical usage per the user's manual. All I/O cables were positioned to simulate typical usage. The actual test configuration, please refer to EUT test photos.
- d. The initial step in collecting radiated emission data is a Spectrum Mode scanning the measurement frequency range.

Below 1GHz:

Reading in which marked as QP or Peak means measurements by using Spectrum Mode with detector RBW=120kHz.

If the Spectrum Mode measured peak value compliance with and lower than Quasi Peak Limit, the EUT shall be deemed to meet QP Limits.

Above 1GHz:

Reading in which marked as Peak & AVG means measurements by using Spectrum Mode with setting in RBW=1MHz.

If the Spectrum Mode measured value compliance with the Peak Limits and lower than AVG Limits, the EUT shall be deemed to meet both Peak and AVG Limits.

- e. Emission frequency and amplitude were recorded, recording at least six highest emissions. The EUT and cable configuration of the above highest emission levels were recorded. The test data of the worst case was recorded.

4.2.4 Deviation from Test Standard

No deviation

4.2.5 Test Setup

< Radiated Emissions Frequency: 30 MHz to 1000 MHz >

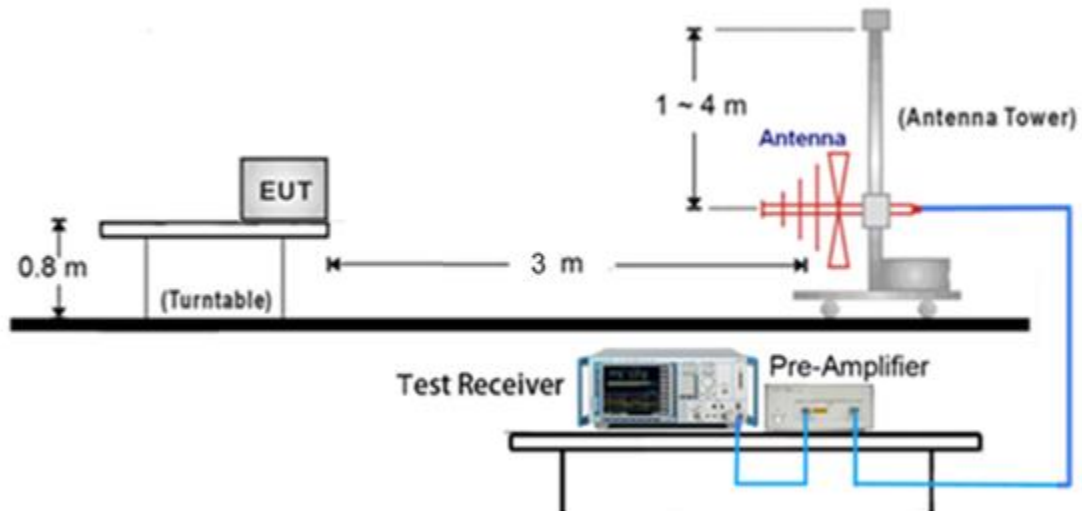

< Radiated Emissions Frequency: above 1GHz >

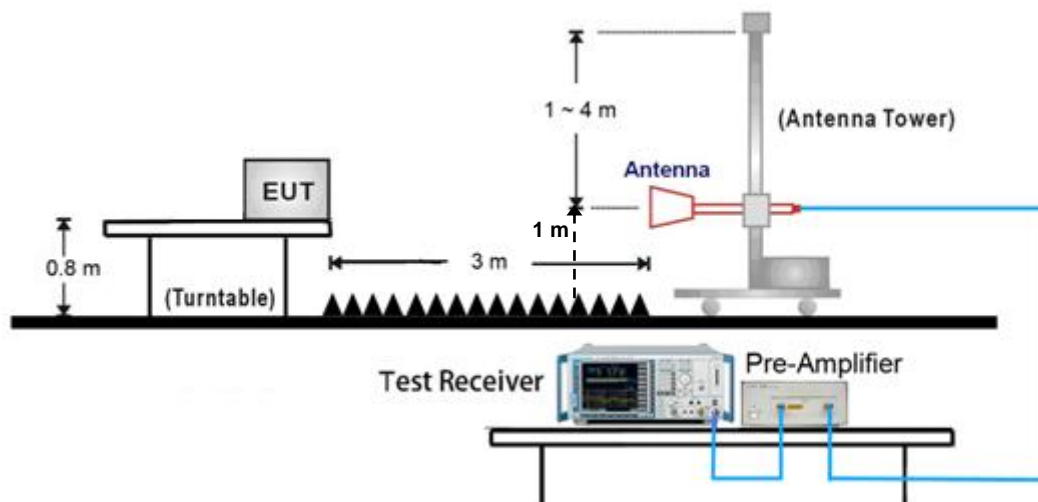

Note:

- (1) Please refer to the 4.3.7 for the actual test configuration.
- (2) The formula of measured value as: $\text{Test Result} = \text{Reading} + \text{Correction Factor}$
- (3) Detector function in the form: PK = Peak, QP = Quasi Peak, AV = Average
- (4) The test result calculated as following:
 $\text{Measurement Value} = \text{Reading Level} + \text{Correct Factor}$
 $\text{Correct Factor} = \text{Antenna Factor} + \text{Cable Loss} - \text{Amplifier Gain (if use)}$
 $\text{Margin Level} = \text{Measurement Value} - \text{Limit Value}$

< EUT placement top view and measurement distance >

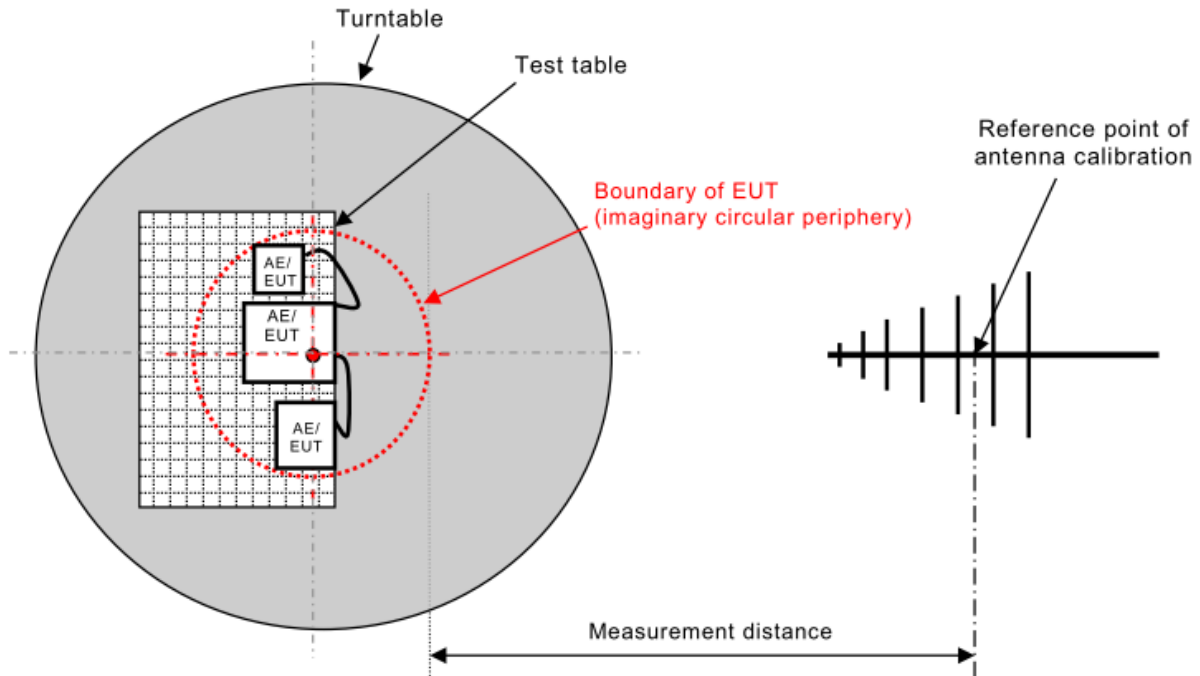

< Boundary of EUT, Local AE and associated cabling >

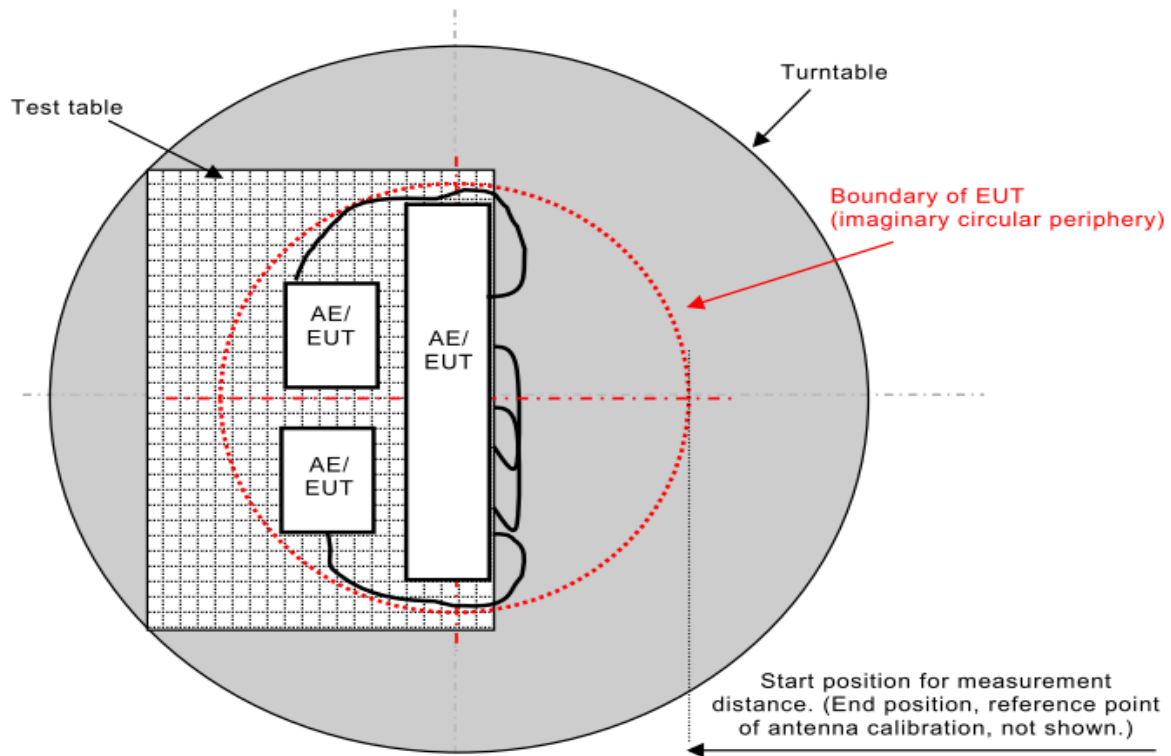

< Table-Top equipment >

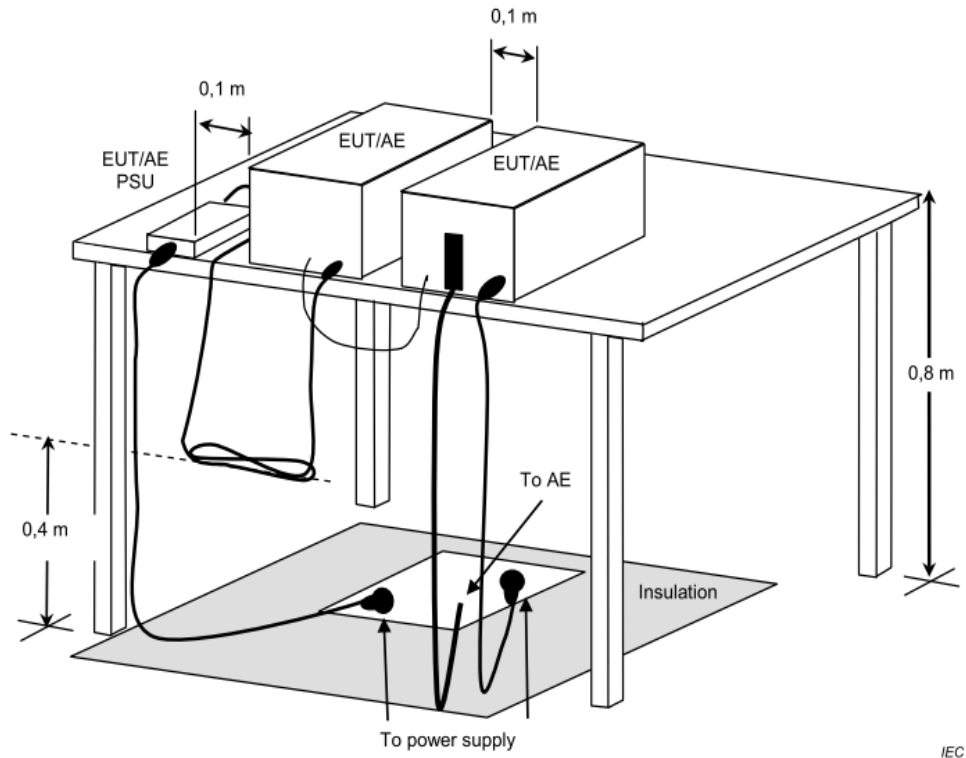

< Floor-Standing equipment >

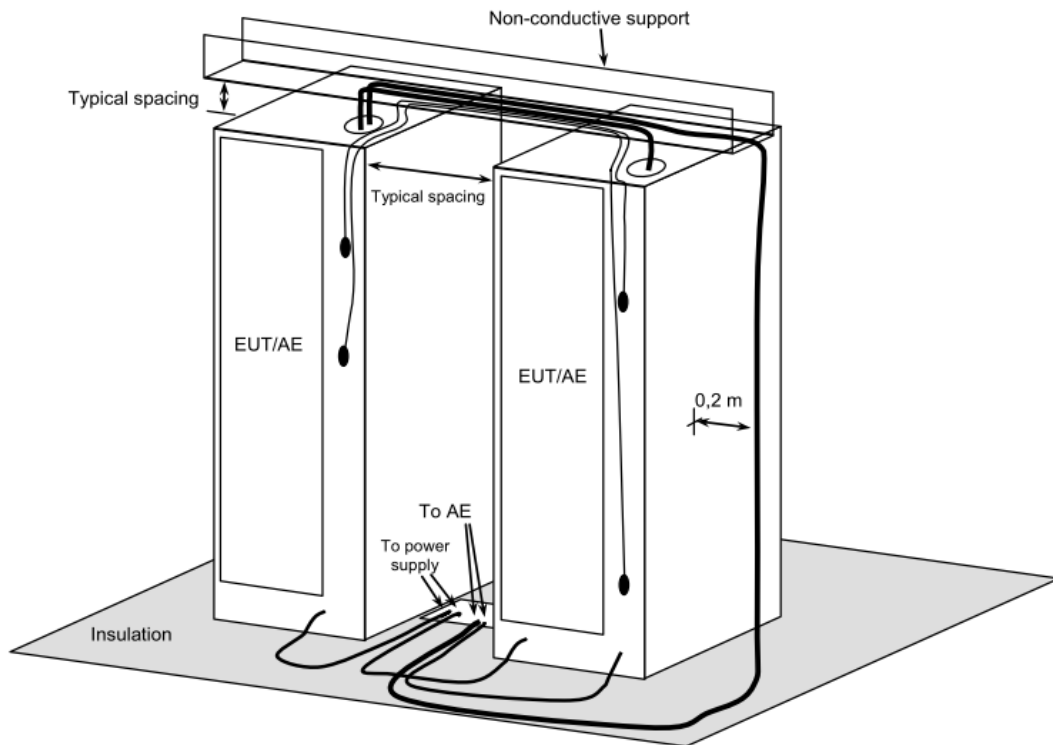

Note: Please refer to the 4.3.7 for the actual test configuration.



4.2.6 Test Result

Test Voltage	230Vac, 50Hz	Frequency Range	30 – 1000 MHz
Environmental Conditions	27°C, 55% RH	6dB Bandwidth	120 kHz
Test Date	2024/07/08	Test Distance	3m
Tested by	Karwin Kao	Polarization	Vertical
Test Site	W08-966-1		

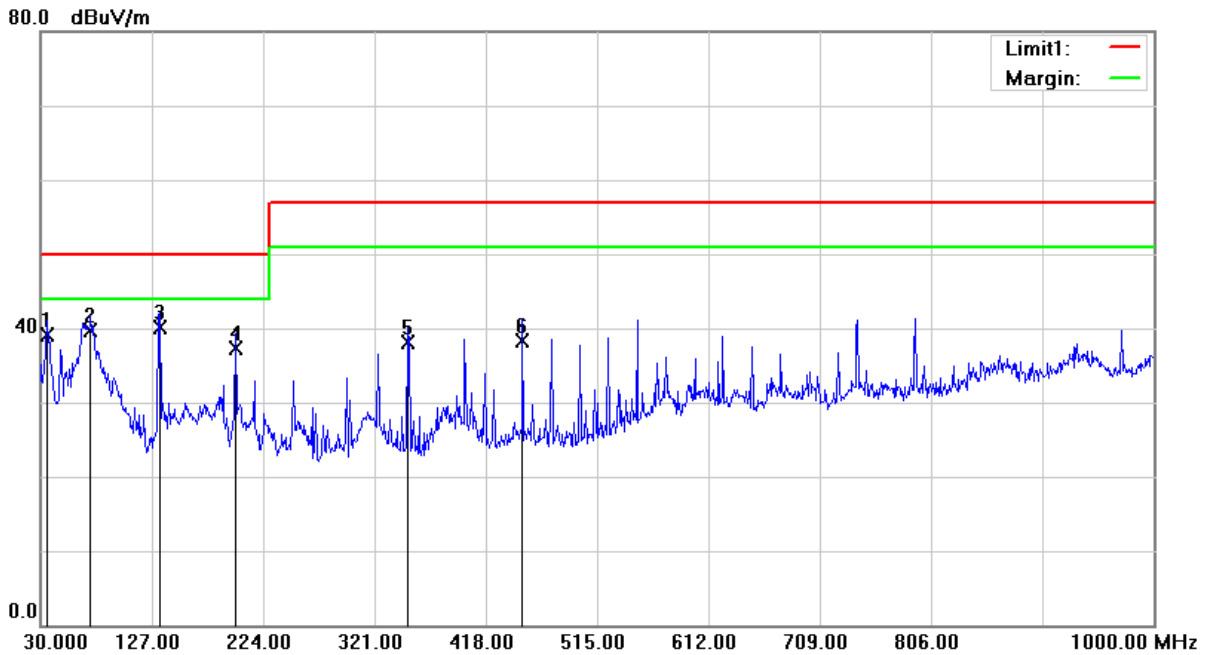

No.	Frequency (MHz)	Reading Level (dBμV)	Correct Factor (dB/m)	Measurement (dBμV/m)	Limit (dBμV/m)	Margin (dB)	Table Degree (degree)	Antenna Height (cm)	Detector
1	35.8200	50.28	-11.16	39.12	50.00	-10.88	209	100	QP
2	73.6500	52.47	-12.81	39.66	50.00	-10.34	195	100	QP
3	133.7900	50.74	-10.73	40.01	50.00	-9.99	74	100	QP
4	199.7500	49.84	-12.59	37.25	50.00	-12.75	155	100	QP
5	350.1000	45.40	-7.30	38.10	57.00	-18.90	172	200	QP
6	450.0100	42.27	-3.97	38.30	57.00	-18.70	311	100	QP

Remark: 1. QP = Quasi Peak
 2. Correction Factor = Antenna factor + Cable loss (Antenna to preamplifier) - preamplifier Gain + Cable loss (preamplifier to receiver)
 3. Measurement Value = Reading Level + Correct Factor
 4. Margin Level = Measurement Value - Limit Value



Test Voltage	230Vac, 50Hz	Frequency Range	30 – 1000 MHz
Environmental Conditions	27°C, 55% RH	6dB Bandwidth	120 kHz
Test Date	2024/07/08	Test Distance	3m
Tested by	Karwin Kao	Polarization	Horizontal
Test Site	W08-966-1		

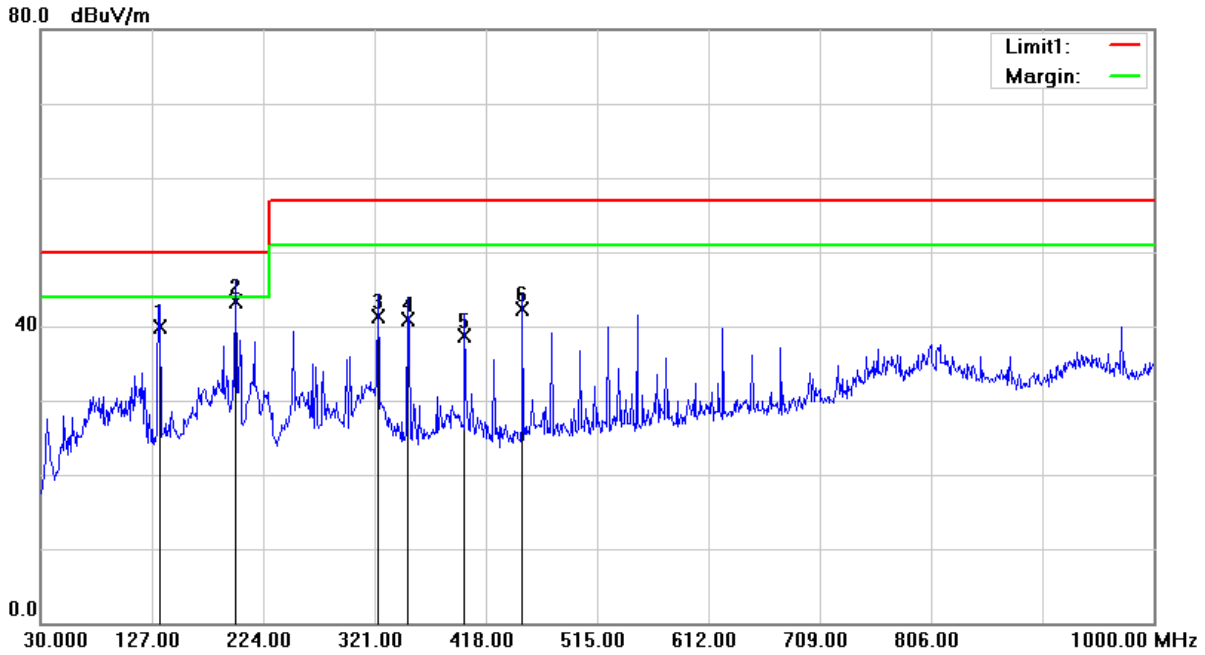

No.	Frequency (MHz)	Reading Level (dBμV)	Correct Factor (dB/m)	Measurement (dBμV/m)	Limit (dBμV/m)	Margin (dB)	Table Degree (degree)	Antenna Height (cm)	Detector
1	133.7900	50.68	-10.73	39.95	50.00	-10.05	265	200	QP
2	199.7500	55.80	-12.59	43.21	50.00	-6.79	333	200	QP
3	323.9100	49.00	-7.74	41.26	57.00	-15.74	293	100	QP
4	350.1000	48.12	-7.30	40.82	57.00	-16.18	276	100	QP
5	399.5700	44.50	-5.77	38.73	57.00	-18.27	219	100	QP
6	450.0100	46.23	-3.97	42.26	57.00	-14.74	80	100	QP

Remark: 1. QP = Quasi Peak
 2. Correction Factor = Antenna factor + Cable loss (Antenna to preamplifier) - preamplifier Gain + Cable loss (preamplifier to receiver)
 3. Measurement Value = Reading Level + Correct Factor
 4. Margin Level = Measurement Value - Limit Value



Test Voltage	230Vac, 50Hz	Frequency Range	1 – 6GHz
Environmental Conditions	27°C, 55% RH	6dB Bandwidth	1MHz
Test Date	2024/07/08	Test Distance	3m
Tested by	Karwin Kao	Polarization	Vertical
Test Site	W08-966-1		

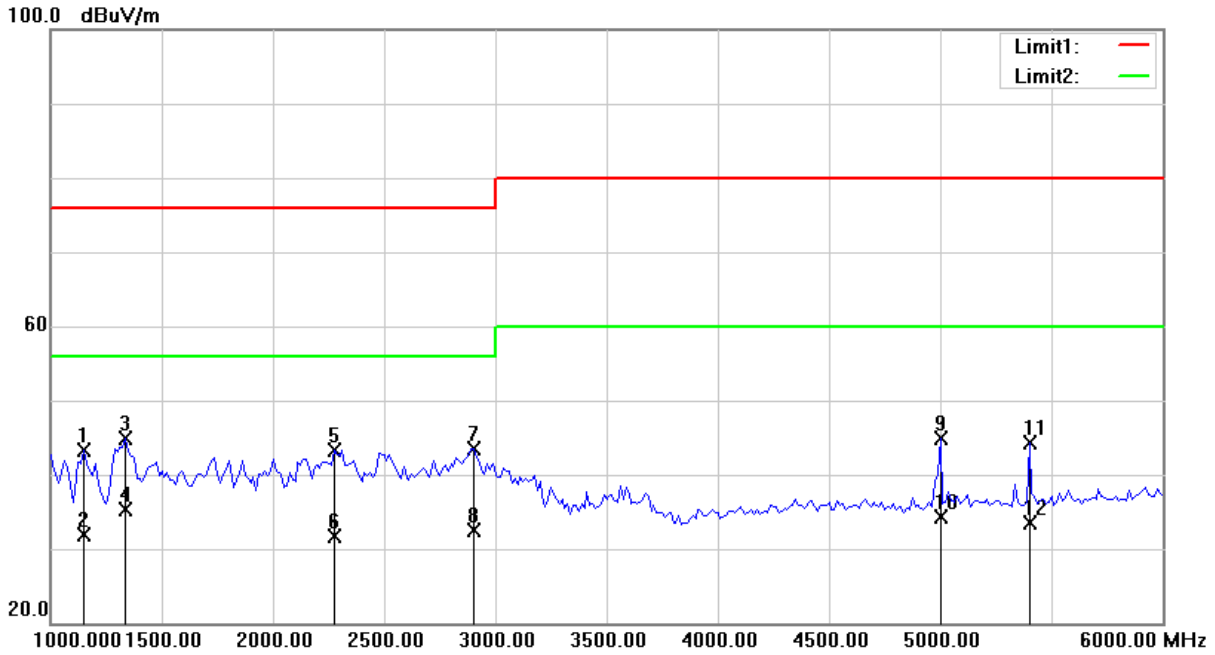

No.	Frequency (MHz)	Reading Level (dBμV)	Correct Factor (dB/m)	Measurement (dBμV/m)	Limit (dBμV/m)	Margin (dB)	Table Degree (degree)	Antenna Height (cm)	Detector
1	1150.000	62.53	-19.27	43.26	76.00	-32.74	149	100	peak
2	1150.000	51.27	-19.27	32.00	56.00	-24.00	149	100	AVG
3	1337.500	63.28	-18.29	44.99	76.00	-31.01	120	100	peak
4	1337.500	53.52	-18.29	35.23	56.00	-20.77	120	100	AVG
5	2275.000	57.92	-14.61	43.31	76.00	-32.69	180	100	peak
6	2275.000	46.35	-14.61	31.74	56.00	-24.26	180	100	AVG
7	2900.000	56.83	-13.31	43.52	76.00	-32.48	205	100	peak
8	2900.000	45.87	-13.31	32.56	56.00	-23.44	205	100	AVG
9	5000.000	53.13	-8.27	44.86	80.00	-35.14	202	100	peak
10	5000.000	42.57	-8.27	34.30	60.00	-25.70	202	100	AVG
11	5400.000	52.19	-7.85	44.34	80.00	-35.66	155	100	peak
12	5400.000	41.29	-7.85	33.44	60.00	-26.56	155	100	AVG

Remark: 1. peak = Peak, AVG = Average
 2. Correction Factor = Antenna factor + Cable loss (Antenna to preamplifier) - preamplifier Gain + Cable loss (preamplifier to receiver)
 3. Measurement Value = Reading Level + Correct Factor
 4. Margin Level = Measurement Value - Limit Value



Test Voltage	230Vac, 50Hz	Frequency Range	1 – 6GHz
Environmental Conditions	27°C, 55% RH	6dB Bandwidth	1MHz
Test Date	2024/07/08	Test Distance	3m
Tested by	Karwin Kao	Polarization	Horizontal
Test Site	W08-966-1		

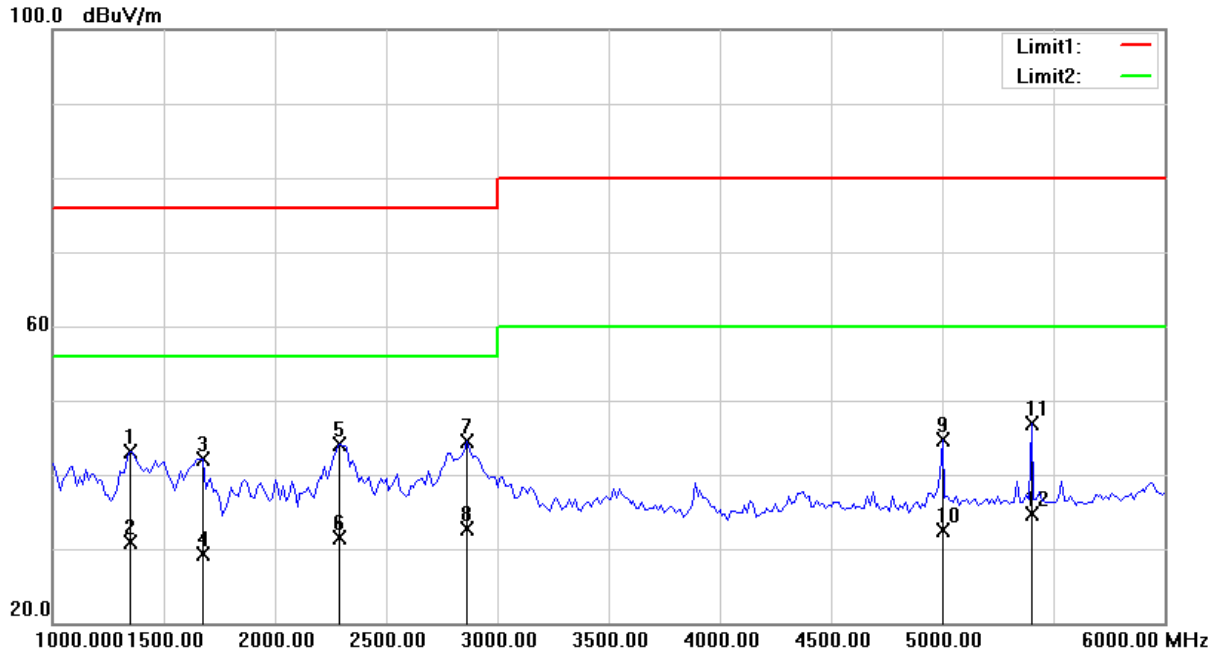

No.	Frequency (MHz)	Reading Level (dBμV)	Correct Factor (dB/m)	Measurement (dBμV/m)	Limit (dBμV/m)	Margin (dB)	Table Degree (degree)	Antenna Height (cm)	Detector
1	1350.000	61.43	-18.32	43.11	76.00	-32.89	216	100	peak
2	1350.000	49.28	-18.32	30.96	56.00	-25.04	216	100	AVG
3	1675.000	60.65	-18.53	42.12	76.00	-33.88	163	100	peak
4	1675.000	47.84	-18.53	29.31	56.00	-26.69	163	100	AVG
5	2287.500	58.80	-14.65	44.15	76.00	-31.85	150	100	peak
6	2287.500	46.11	-14.65	31.46	56.00	-24.54	150	100	AVG
7	2862.500	58.01	-13.44	44.57	76.00	-31.43	125	100	peak
8	2862.500	46.06	-13.44	32.62	56.00	-23.38	125	100	AVG
9	5000.000	52.93	-8.27	44.66	80.00	-35.34	213	100	peak
10	5000.000	40.71	-8.27	32.44	60.00	-27.56	213	100	AVG
11	5400.000	54.68	-7.85	46.83	80.00	-33.17	131	100	peak
12	5400.000	42.59	-7.85	34.74	60.00	-25.26	131	100	AVG

Remark: 1. peak = Peak, AVG = Average
 2. Correction Factor = Antenna factor + Cable loss (Antenna to preamplifier) - preamplifier Gain + Cable loss (preamplifier to receiver)
 3. Measurement Value = Reading Level + Correct Factor
 4. Margin Level = Measurement Value - Limit Value

4.2.7 Photographs of Test Configuration

Radiated Emission Test (30MHz~1GHz)

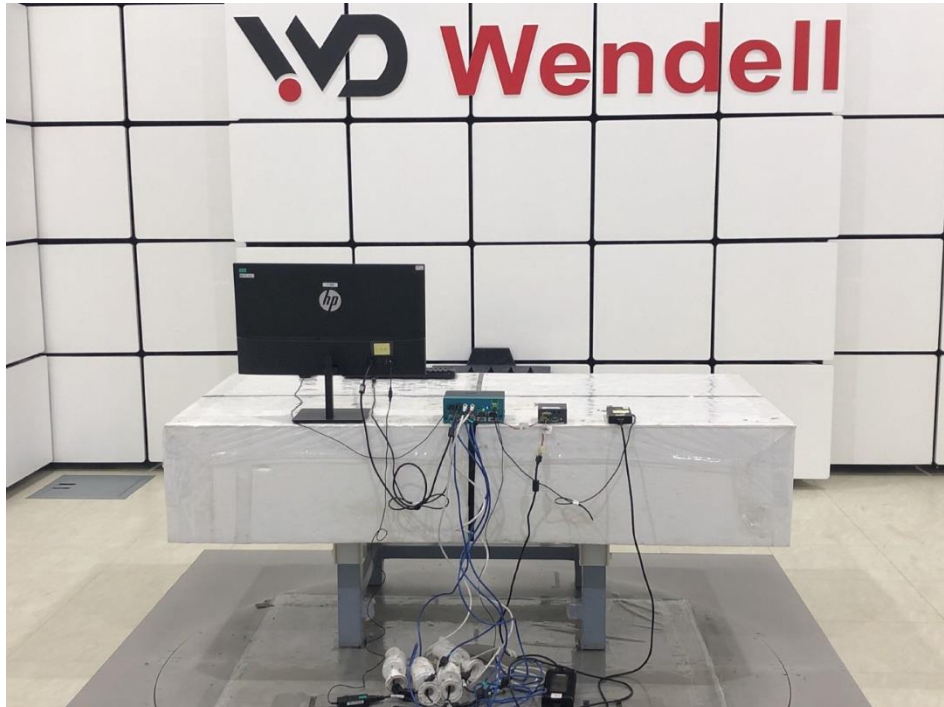

Radiated Emission Test (Above 1GHz)



4.3 Harmonics Current Measurement

4.3.1 Limits of Harmonics Current Measurement

The limits ensure that harmonic disturbance levels do not exceed the compatibility levels defined in IEC 61000-3-2.

Limits for Class A equipment	
Harmonics Order n	Max. permissible harmonics current A
Odd harmonics	
3	2.30
5	1.14
7	0.77
9	0.40
11	0.33
13	0.21
15<=n<=39	0.15x15/n
Even harmonics	
2	1.08
4	0.43
6	0.30
8<=n<=40	0.23x8/n

Limits for Class D equipment		
Harmonics Order n	Max. permissible harmonics current per watt mA/W	Max. permissible harmonics current A
Odd Harmonics only		
3	3.4	2.30
5	1.9	1.14
7	1.0	0.77
9	0.5	0.40
11	0.35	0.33
13	0.30	0.21
15<=n<=39	3.85/n	0.15x15/n

- Note:** 1. Class A and Class D are classified according to item section 5 of EN 61000-3-2.
 2. According to section 7 of EN 61000-3-2, the above limits for all equipment except for lighting equipment having an active input power > 75 W and no limits apply for equipment with an active input power up to and including 75 W.

4.3.2 Test Instrument

Item	Equipment	Manufacturer	Model	Meter No.	Calibration Date
1	Harmonics & Flicker Analyser	EMC PARTNER	HAR-1000-1P	CT-1-090(1)	Oct. 19, 2023
2	Power Source	EMC PARTNER	PS3-1	CT-1-090a1	Oct. 19, 2023

- Note:** 1. The calibration interval of the above test instruments is 12 months.

4.3.3 Test Procedure

The table-top EUT was placed on the top of a wooden table 0.8 meter above the ground and operated to produce the maximum harmonic under normal operating conditions for each successive harmonic component in turn. The floor-standing EUT was placed insulation support unit from the horizontal ground plane.

The classification of EUT is according to section 5 of EN 61000-3-2.

The EUT classified as follows:

Class A:

- Balanced three-phase equipment;
- Household appliances excluding equipment identified as Class D;
- Tools excluding portable tools;
- Dimmers for incandescent lamps;
- Audio equipment.

Equipment not specified in one of the three other classes should be considered as Class A equipment.

Note 1: Equipment that can be shown to have a significant effect on the supply system may be reclassified in a future edition of the standard. Factors to be taken into account include:

- Number in use;
- Duration of use;
- Simultaneity of use;
- Power consumption;
- Harmonic spectrum, including phase.

Class B:

- Portable tools;
- Arc welding equipment, which is not professional equipment.

Class C:

- Lighting equipment;

Class D:

Equipment having a specified power according to 6.2.2 less than or equal to 600W, of the following types:

- Personal computers and personal computer monitors;
- Television receivers.
- Refrigerators and freezers having one or more variable-speed drives to control compressor motor(s).

4.3.4 Deviation from Test Standard

No deviation

4.3.5 Test Setup

< Table-Top equipment >

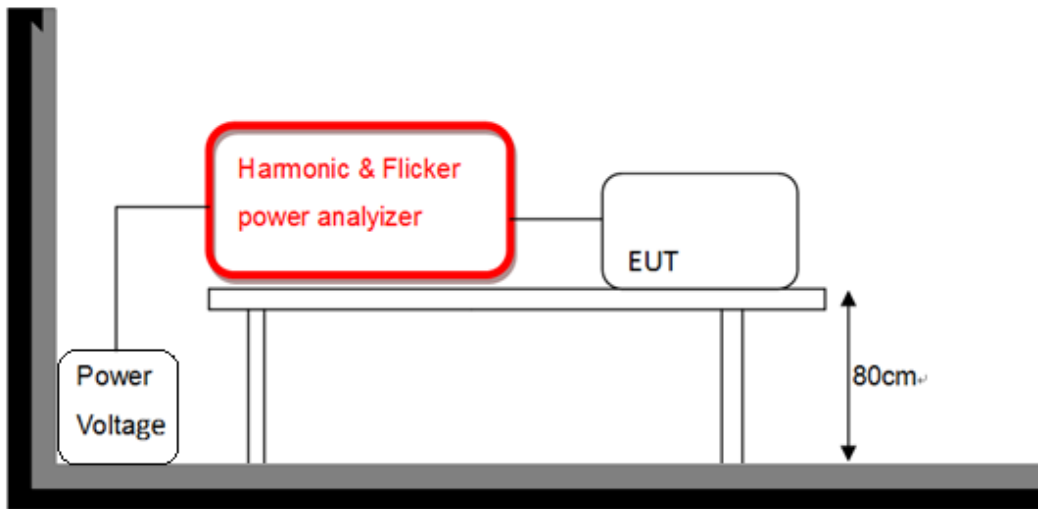

< Floor-Standing equipment >

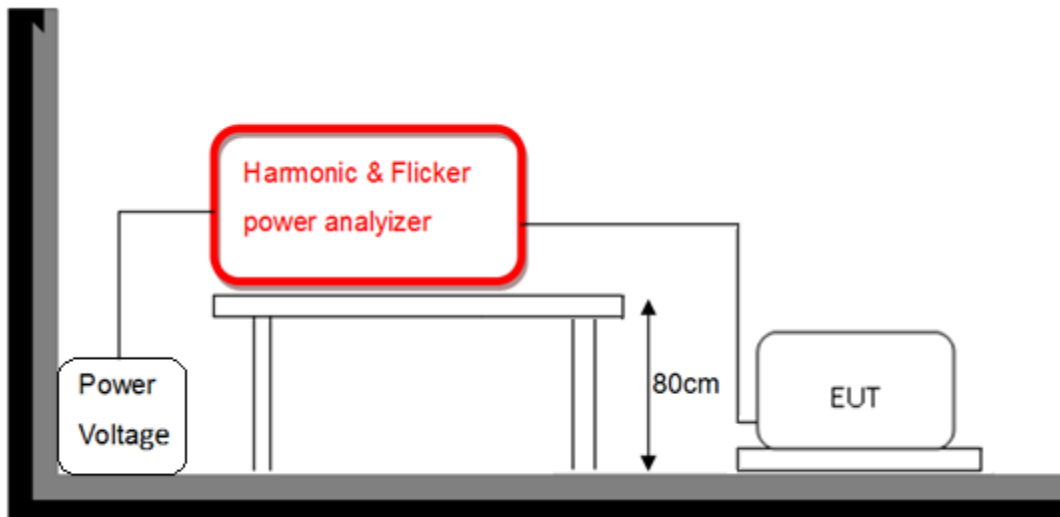



4.3.6 Test Result

Supply Voltage / Ampere	229.7 V _{rms} / 0.251 A _{rms}	Test Date	2024/07/03
Test Duration	5 min	Power Consumption	50.80W
Power Frequency	49.935Hz	Power Factor	0.881
Environmental Conditions	22°C, 50% RH	Tested by	Alan Chung

Note:

1. Limits are not specified for equipment with a rated power of 75W or less (other than lighting equipment).
2. According to EN 61000-3-2 the manufacturer shall specify the power of the apparatus. This value shall be used for establishing limits. The specified power shall be within +/-10% of the measured power.

4.3.7 Photographs of Test Configuration

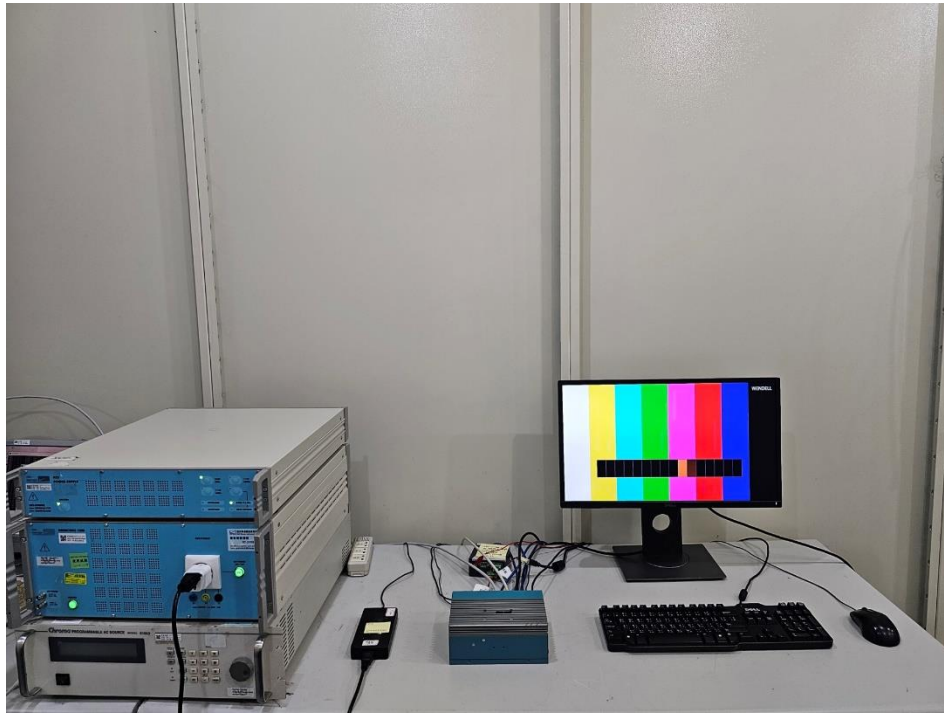

4.4 Voltage Fluctuation and Flicker Measurement

4.4.1 Limit for Voltage Function and Flicker Measurement

Tests Item	Limits	Remark
	IEC/EN 61000-3-3	
P _{st}	1.0, T _p = 10 min.	P _{st} means short-term flicker
P _{lt}	0.65, T _p =2 hr.	P _{lt} means long-term flicker
dc (%)	3.3%	dc means relative steady-state voltage change
d _{max} (%)	4%	d _{max} means maximum relative voltage change.
T _{dt}	3.3% / 500 ms	T _{dt} means maximum time that dt exceeds 3.3 %.

4.4.2 Test Instrument

Item	Equipment	Manufacturer	Model	Meter No.	Calibration Date
1	Harmonics & Flicker Analyser	EMC PARTNER	HAR-1000-1P	CT-1-090(1)	Oct. 19, 2023
2	Power Source	EMC PARTNER	PS3-1	CT-1-090a1	Oct. 19, 2023

Note: 1. The calibration interval of the above test instruments is 12 months.

4.4.3 Test Procedure

The table-top EUT was placed on the top of a wooden table 0.8 meter above the ground and operated to produce the most unfavorable sequence of voltage changes under normal operating condition. The floor-standing EUT was placed insulation support unit from the horizontal ground plane.

During the flick measurement, the measure time shall include that part of whole operation cycle in which the EUT produce the most unfavorable sequence of voltage changes. The observation period for short-term flicker indicator is 10 min and the observation period for long-term flicker indicator is 2 hours.

4.4.4 Deviation from Test Standard

No deviation

4.4.5 Test Setup

< Table-Top equipment >

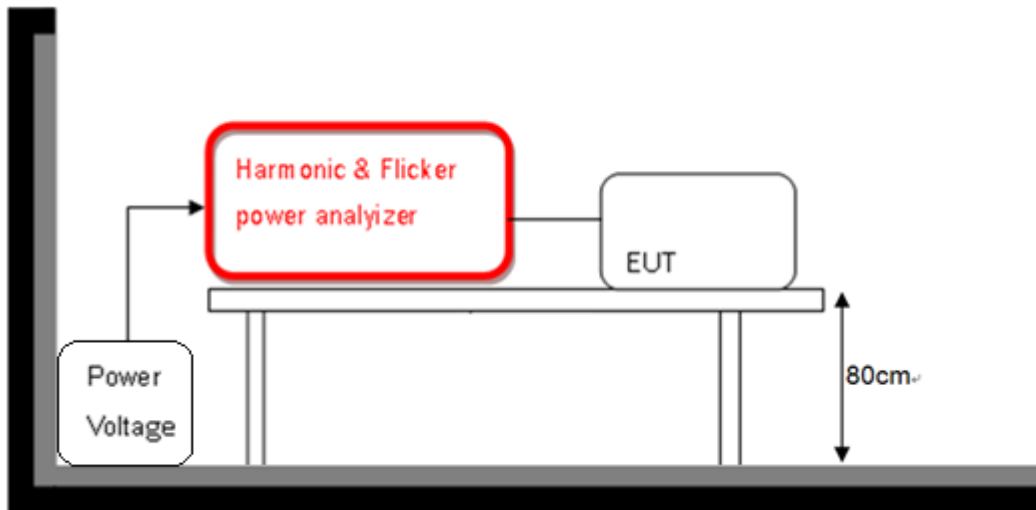

< Floor-Standing equipment >

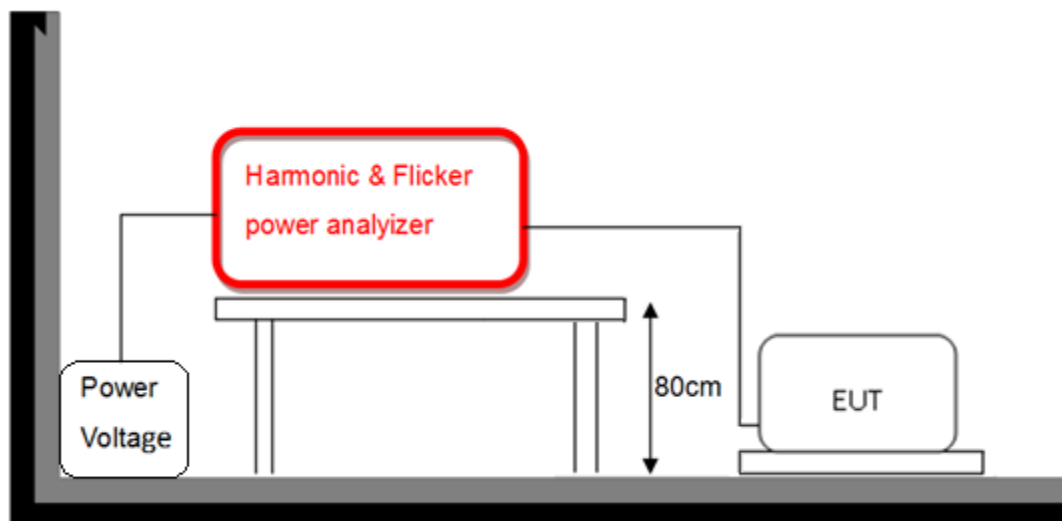



4.4.6 Test Result

Supply Voltage / Ampere	229.5 Vrms / 0.200 Arms	Test Date	2024/07/03
Observation (Tp)	30 min	Environmental Conditions	22°C, 50% RH
Power Frequency	49.922Hz	Tested by	Alan Chung

Test Parameter	Measurement Value	Test Limit	Remarks
P _{st}	0.07	1.00	Pass
P _{lt}	0.07	0.65	Pass
T _{dt} (ms)	0.00	500	Pass
d _{max} (%)	0.00	4%	Pass
dc (%)	0.01	3.3%	Pass

- Note:**
1. P_{st} means short-term flicker indicator.
 2. P_{lt} means long-term flicker indicator.
 3. T_{dt} means maximum time that dt exceeds 3.3 %.
 4. d_{max} means maximum relative voltage change.
 5. dc means relative steady-state voltage change.

4.4.7 Photographs of Test Configuration

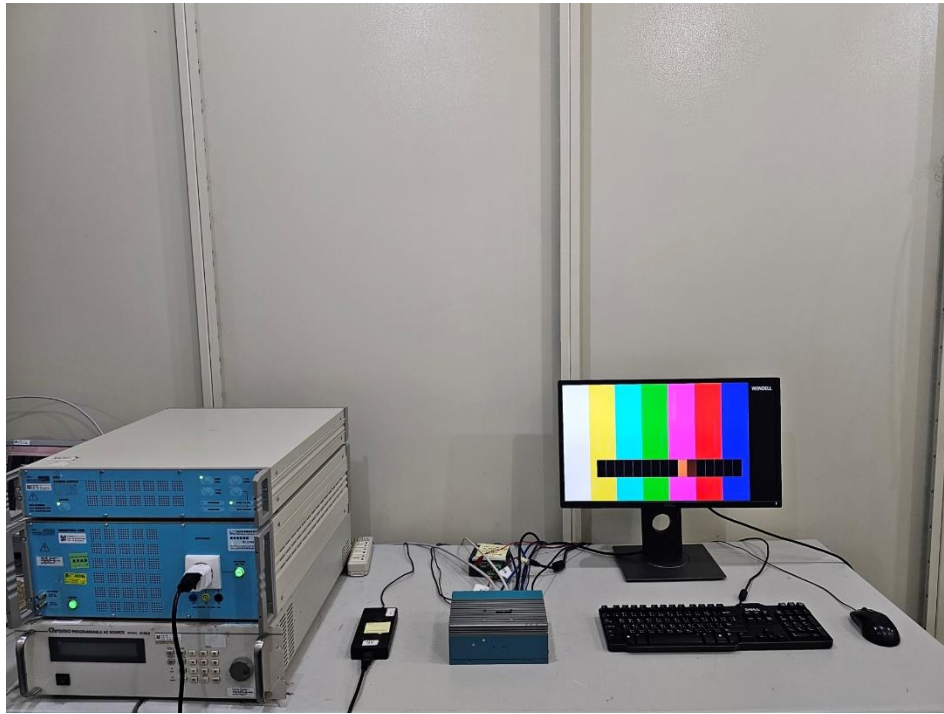

5 Immunity Test

5.1 Standard Description

Product standard	EN 50121-3-2	
Basic Standard and Performance Criterion required	EN 61000-4-2 (ESD)	±8kV Air discharge ±6kV Contact discharge, Performance Criterion B
	EN IEC 61000-4-3 (RS)	Radio-frequency electromagnetic field amplitude modulated ^(Note1) 80 ~ 800 MHz, 20 V/m(rms), 80% AM (1kHz) Radio-frequency electromagnetic field ^(Note2) 800~ 1000 MHz, 20 V/m, 80% AM (1kHz) 1400 ~ 2000 MHz, 10 V/m, 80% AM (1kHz) 2000~ 2700 MHz, 5 V/m, 80% AM (1kHz) 5100~ 6000 MHz, 3 V/m, 80% AM (1kHz) Performance Criterion A
	EN 61000-4-4 (EFT)	Power Port: ±2kV Signal / Control Ports (cable length > 3m): ±2kV Performance Criterion A
	EN 61000-4-5 (Surge)	Power Port: line to line ±1kV, 42Ω, 0.5μF line to ground ±2kV, 42Ω, 0.5μF Performance Criteria B
	EN 61000-4-6 (CS)	Power Port and Signal / Control Ports (cable length > 3m) 0.15 ~ 80 MHz, 10V, 80% AM (1kHz) Performance Criterion A

Note 1: This limit applies to equipment mounted in the passenger compartments, drivers cab or external to the rolling stock (roof, underframe). For equipment mounted in all other areas a severity level of 10V/m may be used.

Note 2: For large apparatus (e.g. traction drives, auxiliary converters) it is often not practical to perform the immunity test to radiated electromagnetic fields on the complete unit. In such cases the manufacturer should test susceptible sub-systems (e.g. control electronics). The test report should justify the selection or not of sub-systems and any assumptions made (e.g. reduction of field due to case shielding).

5.2 Performance Criteria

According to EN 50121-1 standard, the general performance criteria as following:

Criteria A	The apparatus shall continue to operate as intended during and after the test. No degradation of performance or loss of function is allowed below a performance level specified by the manufacturer, when the apparatus is used as intended. The performance level may be replaced by a permissible loss of performance. If the minimum performance level or the permissible performance loss is not specified by the manufacturer, either of these may be derived from the product description and documentation, and from what the user may reasonably expect from the apparatus if used as intended.
Criteria B	The apparatus shall continue to operate as intended after the test. No degradation of performance or loss of function is allowed below a performance level specified by the manufacturer, when the apparatus is used as intended. The performance level may be replaced by a permissible loss of performance. During the test, degradation of performance is however allowed. No change of actual operating state or stored data is allowed. If the minimum performance level or the permissible performance loss is not specified by the manufacturer, either of these may be derived from the product description and documentation, and from what the user may reasonably expect from the apparatus if used as intended.
Criteria C	Temporary loss of function is allowed, provided the function is self-recoverable or can be restored by the operation of the controls.

5.3 Electrostatic Discharge (ESD)

5.3.1 Test Specification

Standard	EN 61000-4-2
Discharge Impedance	330 ohm / 150 pF
Discharge Voltage	Air Discharge: $\pm 2, \pm 4, \pm 8$ kV (Direct) Contact Discharge: ± 6 kV (Direct) and HCP/VCP: ± 6 kV (Indirect)
Number of Discharge	Air: Minimum 10 times at each polarity Contact: Minimum 10 times at each polarity
Discharge Mode	Single Discharge
Discharge Period	1 second minimum

5.3.2 Test Instrument

Item	Equipment	Manufacturer	Model	Meter No.	Calibration Date
1	ESD Generator	TESEQ	NSG 437	CT-1-140	Jun. 15, 2024
2	ESD Generator	NoiseKen	ESS-B3011	CT-1-089	Aug. 04, 2023
3	Digital Thermo-Hygro Meter	N/A	HTC-8	CT-2-047	Jun. 06, 2023
4	Atmosphere pressure meter	TES	TES-1161	CT-5-094	Aug. 10, 2023

- Note:**
1. The calibration interval of the test instruments is 12 months.
 2. The calibration interval of thermo hygrometer/ Atmosphere pressure meter is 24 months.

5.3.3 Test Procedure

The test generator necessary to perform direct and indirect application of discharge to the EUT in following methods:

a. Contact discharges to the conductive surface and coupling planes:

For table-top equipment one of the test points shall be the centre front edge of the horizontal coupling plane, which shall be subjected to at least 20 indirect discharges (10 of each polarity). All other test points shall each receive at least 20 direct contact discharges (10 of each polarity). All areas normally touched by the user should be tested. Test shall be performed at a maximum repetition rate of one discharge per second.

Vertical Coupling Plane (VCP):

The coupling plane, of dimensions 0.5 m × 0.5 m, is placed parallel to, and positioned at a distance 0.1 m from, the EUT, with the discharge electrode touching the coupling plane. The four faces of the EUT will be performed with electrostatic discharge.

Horizontal Coupling Plane (HCP):

The coupling plane, of dimensions 1.6 m × 0.8 m, is placed under the EUT. The generator shall be positioned vertically a distance of 0.1 m from the EUT, with the discharge electrode touching the coupling plane. The four faces of the EUT will be performed with electrostatic discharge.

b. Air discharge at apertures and slots and insulating surface:

On those parts of the EUT where it is not possible to perform contact discharge testing, the equipment should be investigated to identify user accessible points where breakdown may occur. Such points are tested using the air discharge method. This investigation should be restricted to those area normally handled by the user. A minimum 10 single air discharges shall be applied to the selected test point for each such area.

5.3.4 Deviation from Test Standard

No deviation

5.3.5 Test Setup

< Table-Top equipment >

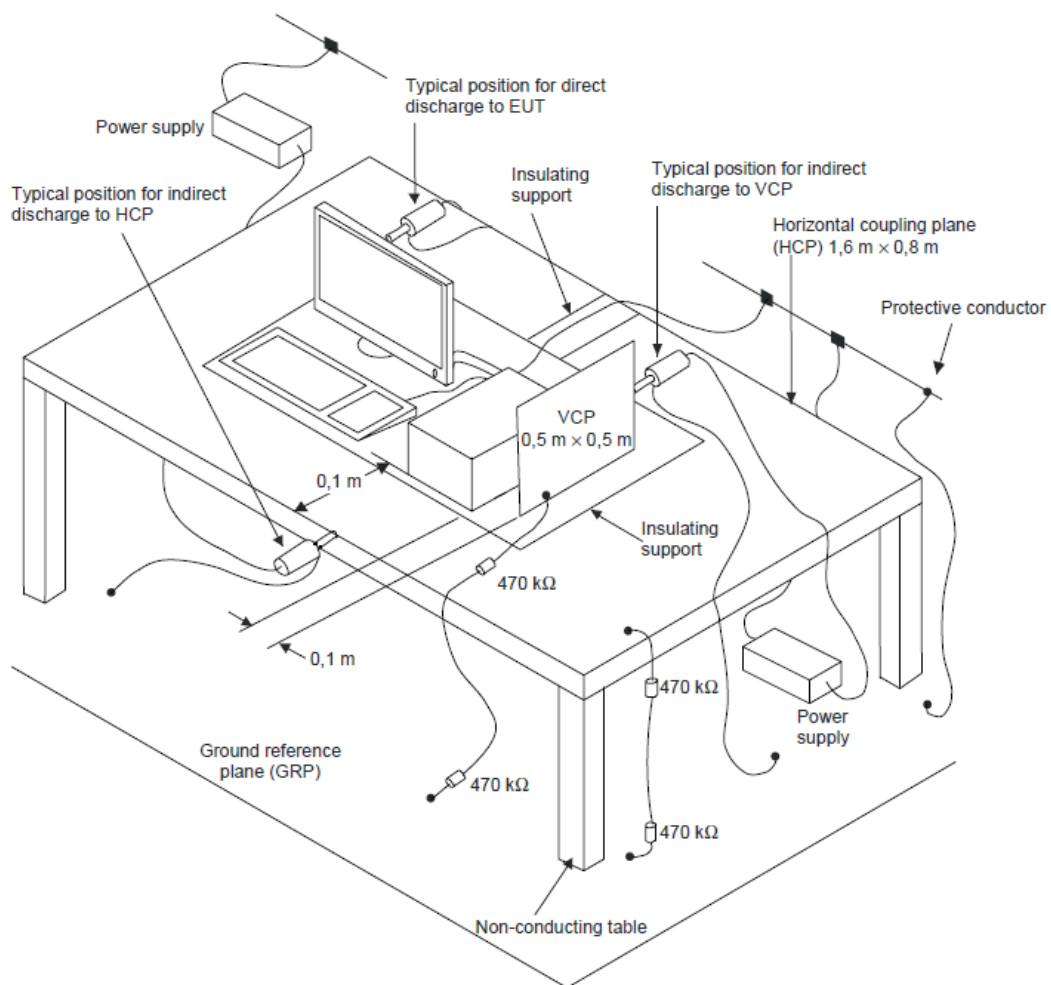

< Floor-Standing equipment >

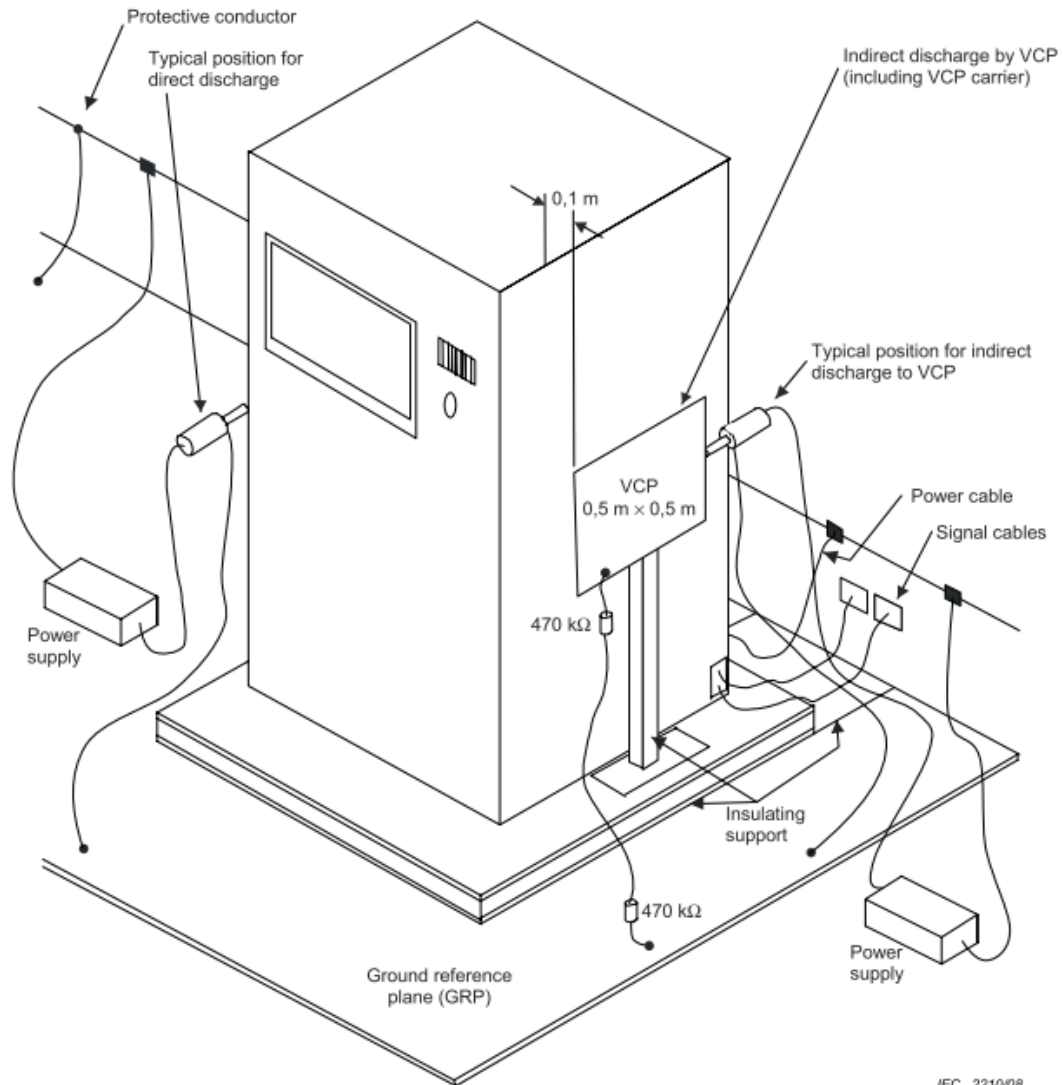



5.3.6 Test Result

Test Voltage	230Vac, 50Hz	Test Date	2024/07/11
Environmental Conditions	24°C, 53% RH	Pressure	1001 mbar
Tested by	Guanwei Liao		

Test Results of Direct Application

Air Discharge				
Test Point	Discharge Level (kV)			Result
	±2	±4	±8	
Front	A (#1)	A (#1)	A (#1)	A
Back	N/A	N/A	N/A	N/A
Left	N/A	N/A	N/A	N/A
Right	N/A	N/A	N/A	N/A
Top	N/A	N/A	N/A	N/A
Bottom	N/A	N/A	N/A	N/A
Other	N/A	N/A	N/A	N/A

* Test location(s) in which discharge to be applied illustrated by photos shown in next page(s).

Contact Discharge			
Test Point	Discharge Level (kV)		Result
	±6		
Front	B (#1)		B
Back	A		A
Left	A		A
Right	A		A
Top	A		A
Bottom	A		A
Other	N/A		N/A

* Test location(s) in which discharge to be applied illustrated by photos shown in next page(s).

Test Results of Indirect Application

HCP Discharge		
Test Point	Discharge Level (kV)	Result
	± 6	
Front	A	A
Back	A	A
Left	A	A
Right	A	A

VCP Discharge		
Test Point	Discharge Level (kV)	Result
	± 6	
Front	A	A
Back	A	A
Left	A	A
Right	A	A

Note:

Criteria A: The EUT function was correct during the test.

Criteria A: (#1) No occur arcing.

Criteria B: (#1) The EUT was interrupted during the test, but could self-recover to the normal mode after the test.

Description of Test Points

Front



Back

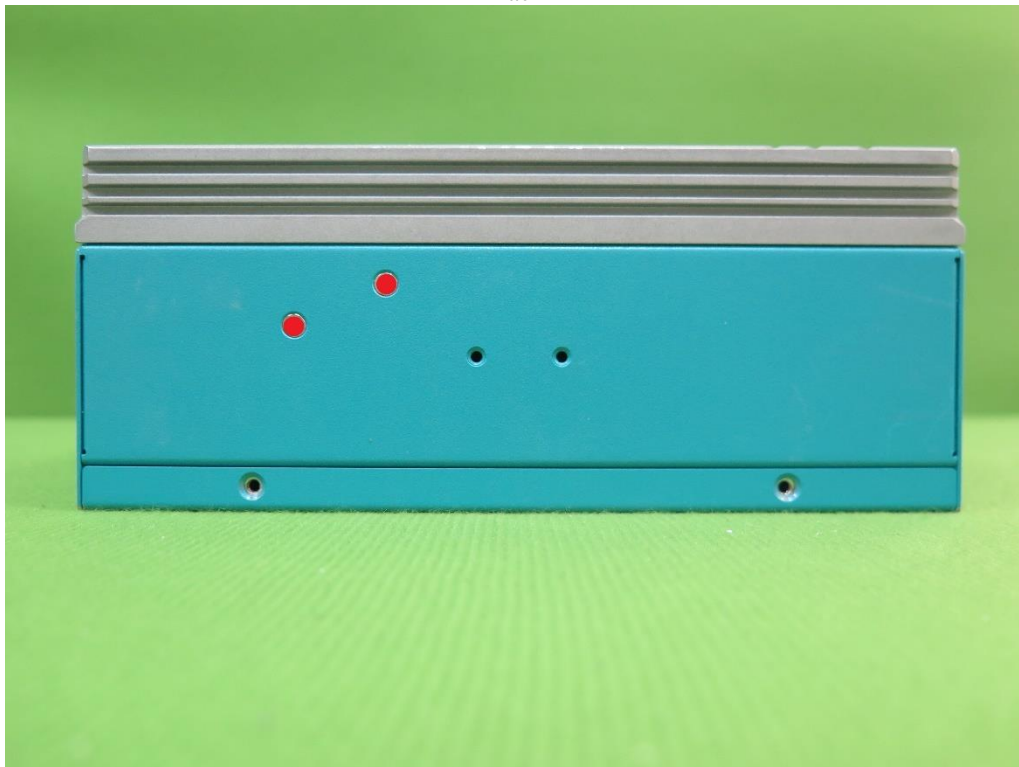

*Red Dot - Contact Discharged
 Blue Dot - Air Discharged

Left

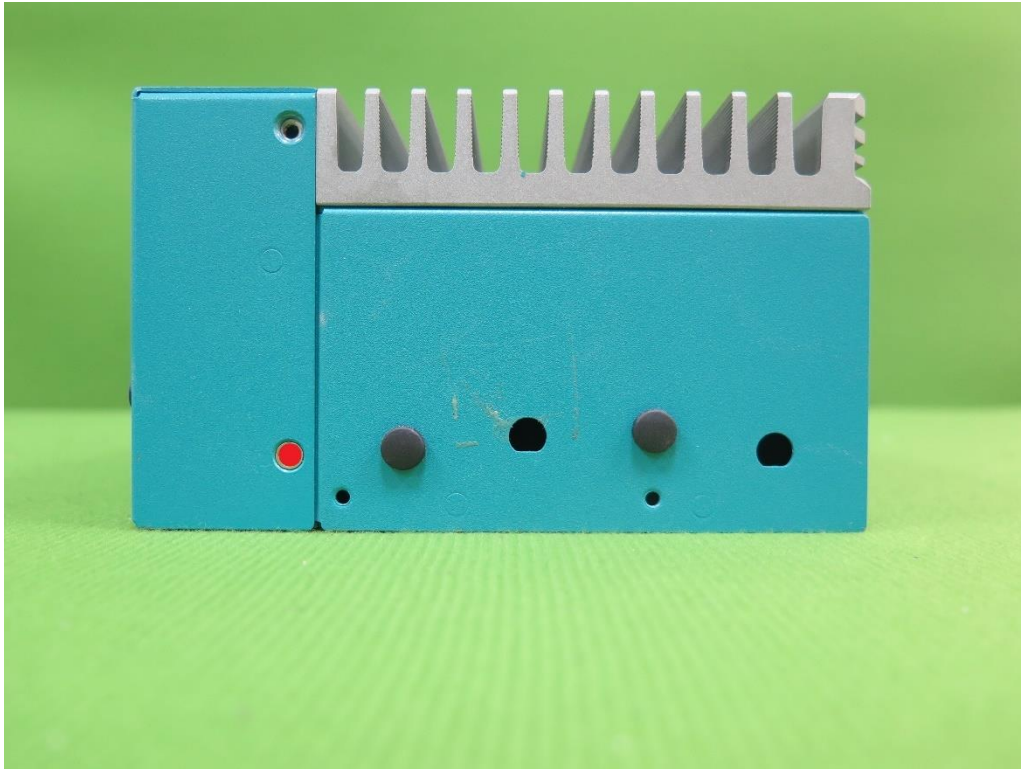

Right



*Red Dot - Contact Discharged
Blue Dot - Air Discharged

Top

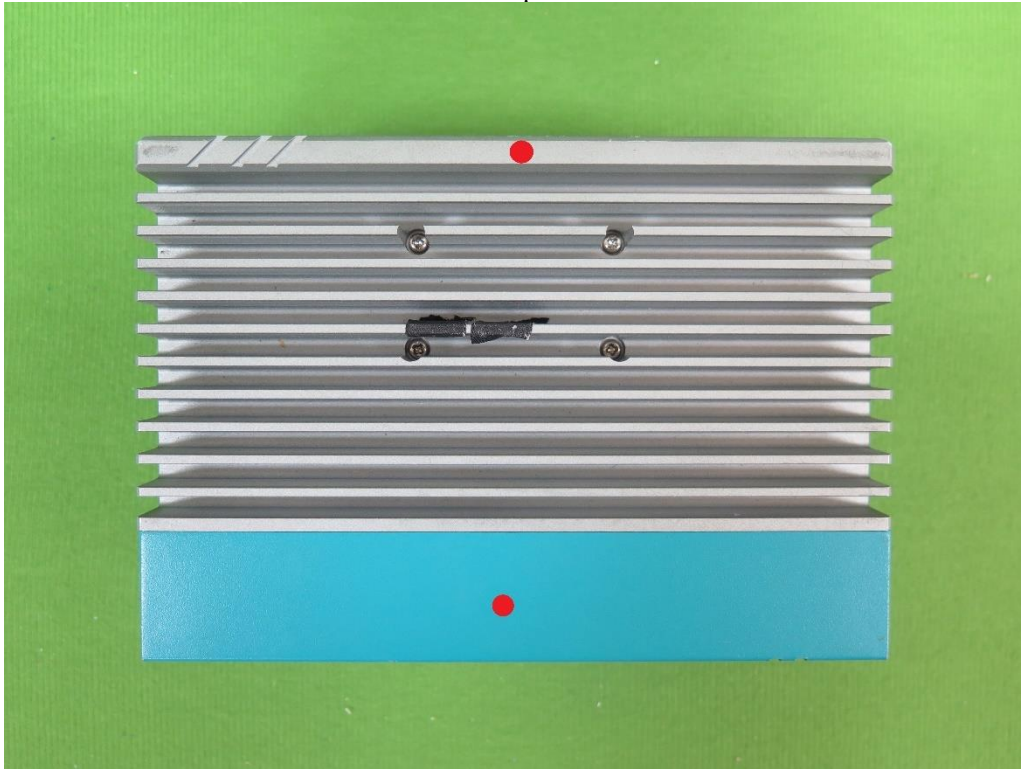

Bottom

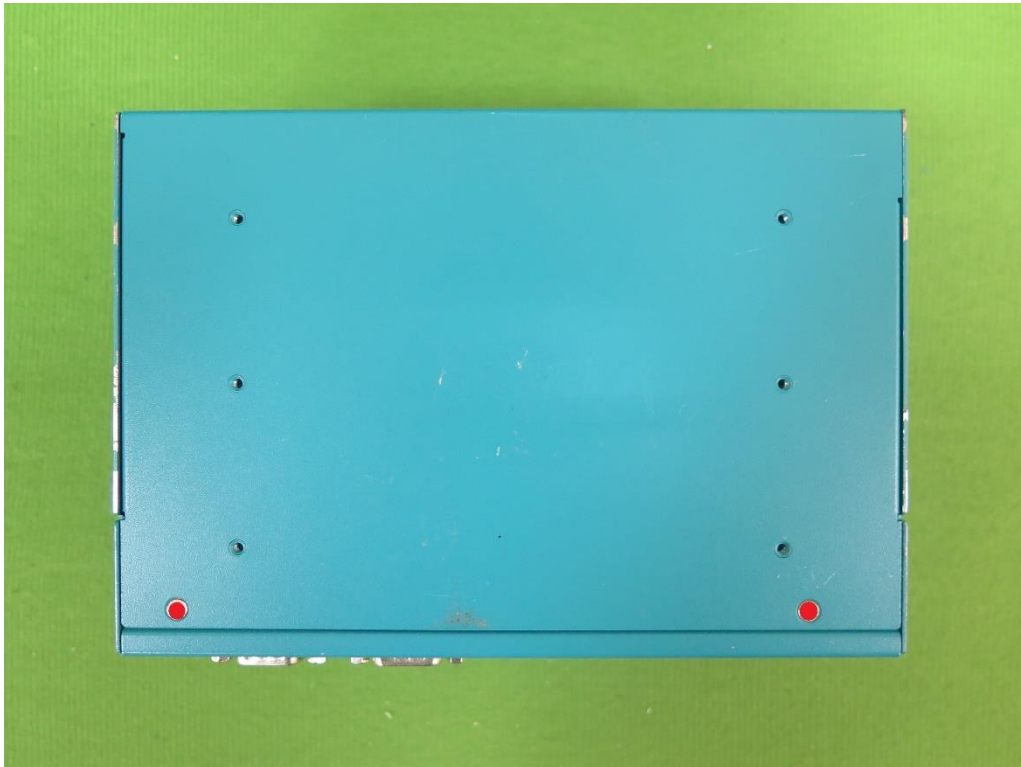

*Red Dot - Contact Discharged
Blue Dot - Air Discharged

5.3.7 Photographs of Test Configuration



5.4 Radiated, Radio-frequency, Electromagnetic Field Immunity Test (RS)

5.4.1 Test Specification

Standard	EN IEC 61000-4-3
Frequency Range/ Field Strength	80MHz - 800MHz: 20 V/m ^(note1) 800MHz - 1000MHz: 20 V/m 1400MHz - 2000MHz: 10 V/m 2000MHz - 2700MHz: 5 V/m 5100MHz - 6000MHz: 3 V/m
Modulation	80%, AM Modulation, 1 kHz Sine Wave
Frequency Step	1%
Polarity of Antenna	Horizontal and Vertical
Test Distance	2.15 m (80MHz - 1000MHz) 1 m (1GHz - 6GHz)
Antenna Height	1.5 m (80MHz - 1000MHz) 1 m (1GHz - 6GHz)
Dwell Time	3.0 seconds

Note 1: This limit applies to equipment mounted in the passenger compartments, drivers cab or external to the rolling stock (roof, underframe). For equipment mounted in all other areas a severity level of 10 V/m may be used.

5.4.2 Test Instrument

Item	Equipment	Manufacturer	Model	Meter No.	Calibration Date
1	RadiCentre ® Modular EMC Test Systems	DARE	CTR1004B	CT-1-080	No calibration request
2	RF Signal Generator	DARE	RGN6000B	CT-1-080	Aug. 06, 2023
3	LINEAR POWER RF AMPLIFIER	TESEQ	CBA1G-300 D	CT-1-163	Aug. 06, 2023
4	LINEAR POWER RF AMPLIFIER	OPHIR	5193	CT-1-083	Aug. 06, 2023
5	LINEAR POWER RF AMPLIFIER	FRANKONIA	FLG-30C	CT-1-061	Aug. 06, 2023
6	Periodic Test-Antenna	Schwarzbeck Mess - Elektronik	STLP 9128 E	CT-1-085	No calibration request
7	Stacked Microwave Log.-Per. Antenna	Schwarzbeck Mess - Elektronik	STLP 9149	CT-1-086	No calibration request
8	Electric Field Probe	FRANKONIA	EFS-10	CT-1-060a1	Sep. 29, 2023
9	Measurement Software	EMC-RS	Ver: 2.0.1.3	N/A	No calibration request

Note: 1. The calibration interval of the above test instruments is 12 months.

5.4.3 Test Procedure

The test procedure was in accordance with EN IEC 61000-4-3.

The table-top EUT and load, which are placed on a table that is 0.8 meter above ground, are placed with one coincident with the calibration plane such that the distance from antenna to the EUT was 2.15 meter at test frequency 80M - 1GHz. (The distance was 1 meter at test frequency 1G - 6GHz)

Both horizontal and vertical polarization of the antenna and four sides of the EUT are set on measurement.

The EUT shall be positioned so that the four sides of the EUT shall be exposed to the electromagnetic field in sequence. In each position the performance of the EUT will be investigated.

In the case where the most sensitive surface side of the EUT is known throughout the frequency range (for example, via preliminary tests), testing may be restricted to that surface side only. Where it is not possible to determine the most sensitive face with any certainty (for example where different faces are sensitive at different frequencies) all four faces shall be tested.

If the EUT is too large such that it cannot be fully illuminated by the radiating antenna, or exceeds the size of the Uniform Field Area (UFA) then partial illumination shall be used. The EUT can be repositioned so that the front surface remains within the UFA in order to illuminate those sections of the EUT that were previously outside the UFA.

In order to judge the EUT performance, a CCD camera is used to monitor EUT screen.

All the scanning conditions are as follows:

	Condition of Test	Remarks
1	Scanning Frequency and Field Strength	80 MHz - 800 MHz: 20 V/m 800 MHz - 1000 MHz: 20 V/m 1400 MHz - 2000 MHz: 10 V/m 2000 MHz - 2700 MHz: 5 V/m 5100 MHz - 6000 MHz: 3 V/m
2	Radiated Signal	AM 80% Modulated with 1kHz
3	Dwell Time	3.0 Seconds
4	Frequency Step Size Δf	1%

5.4.4 Deviation from Test Standard

No deviation

5.4.5 Test Setup

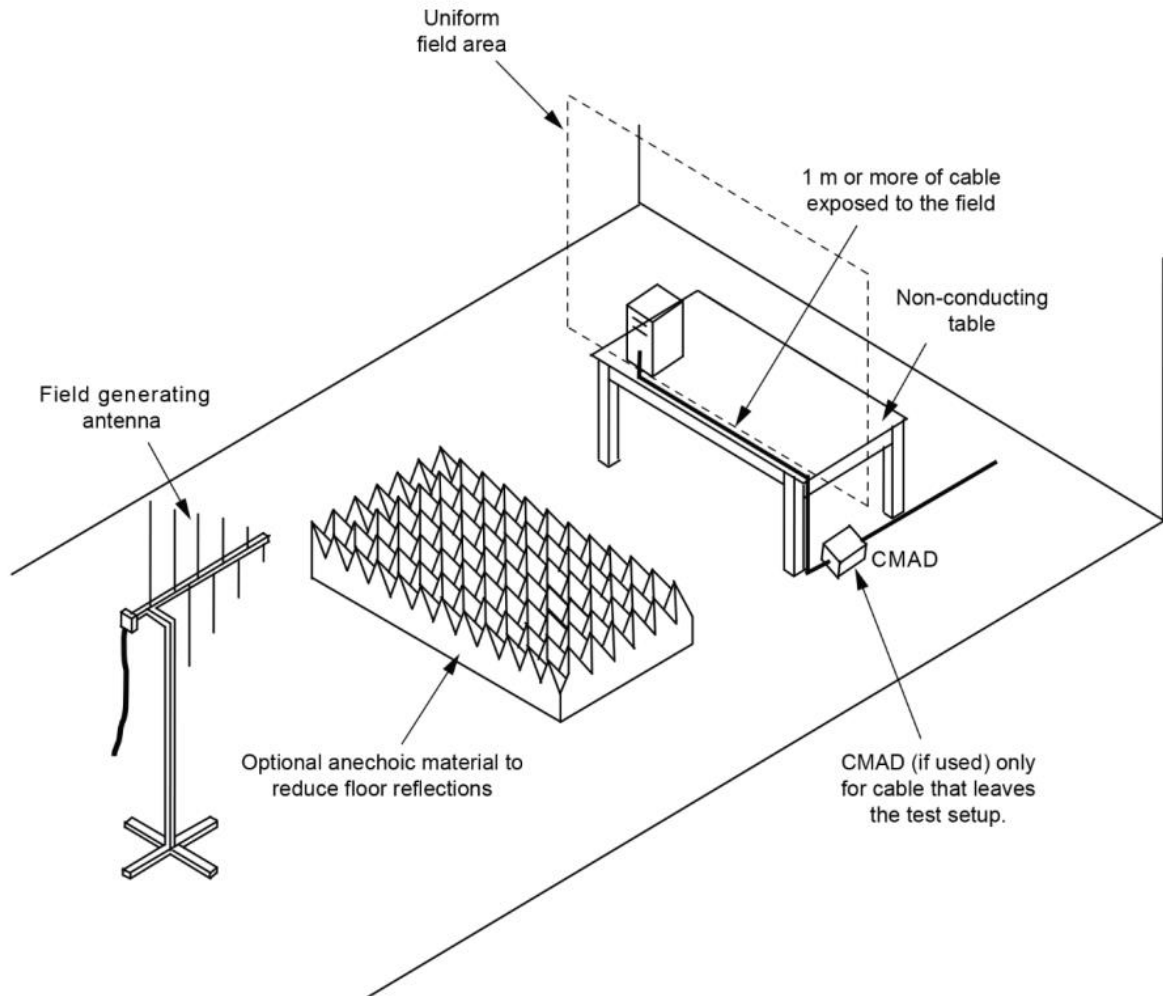



5.4.6 Test Result

Test Voltage	230Vac, 50Hz	Environmental Conditions	24°C, 50% RH
Tested by	Dennis Chen	Test Date	2024/07/02

Frequency Range (MHz)	Azimuth	Polarity	Field Strength (V/m)	Modulation	Result
80-1000	0	H/V	20	80% AM (1kHz)	A
80-1000	90	H/V	20	80% AM (1kHz)	A
80-1000	180	H/V	20	80% AM (1kHz)	A
80-1000	270	H/V	20	80% AM (1kHz)	A

Frequency Range (MHz)	Azimuth	Polarity	Field Strength (V/m)	Modulation	Result
1400-2000	0	H/V	10	80% AM (1kHz)	A
1400-2000	90	H/V	10	80% AM (1kHz)	A
1400-2000	180	H/V	10	80% AM (1kHz)	A
1400-2000	270	H/V	10	80% AM (1kHz)	A

Frequency Range (MHz)	Azimuth	Polarity	Field Strength (V/m)	Modulation	Result
2000-2700	0	H/V	5	80% AM (1kHz)	A
2000-2700	90	H/V	5	80% AM (1kHz)	A
2000-2700	180	H/V	5	80% AM (1kHz)	A
2000-2700	270	H/V	5	80% AM (1kHz)	A



Frequency Range (MHz)	Azimuth	Polarity	Field Strength (V/m)	Modulation	Result
5100-6000	0	H/V	3	80% AM (1kHz)	A
5100-6000	90	H/V	3	80% AM (1kHz)	A
5100-6000	180	H/V	3	80% AM (1kHz)	A
5100-6000	270	H/V	3	80% AM (1kHz)	A

Note:

Criteria A: The EUT function was correct during the test.

5.4.7 Photographs of Test Configuration



5.5 Electrical Fast Transient Immunity Test (EFT)

5.5.1 Test Specification

Standard	EN 61000-4-4
Test Voltage	Power Port: $\pm 2\text{kV}$ Signal / Control Ports (cable length > 3m): $\pm 2\text{kV}$
Polarity	Positive & Negative
Impulse Frequency	5kHz
Impulse Wave	5/50 ns
Burst Duration	15 ms
Burst Period	300 ms
Test Duration	Not less than 1 min.

5.5.2 Test Instrument

Item	Equipment	Manufacturer	Model	Meter No.	Calibration Date
1	EFT Generator	3ctest	EFT500S	CT-1-165	Sep. 20, 2023
2	Clamp	3ctest	CCC100	CT-1-166	Sep. 20, 2023

Note: 1. The calibration interval of the above test instruments is 12 months.

5.5.3 Test Procedure

The table-top EUT was placed on a table that is 0.8 meter height. A ground reference plane is placed on the table, and uses 0.1m insulation between the EUT and ground reference plane. The floor-standing EUT was placed on 0.1m insulation support unit between the EUT and ground reference plane.

The minimum area of the ground reference plane is $1\text{m} \times 1\text{m}$, and 0.65mm thick min, and projected beyond the EUT by at least 0.1m on all sides.

For input power ports:

The EUT is connected to the power ports through a coupling device that directly couples the EFT/B interference signal. Each of the line conductors is impressed with burst noise for 1 minute. The length of the power lines between the coupling device and the EUT is 0.5m.

5.5.4 Deviation from Test Standard

No deviation

5.5.5 Test Setup

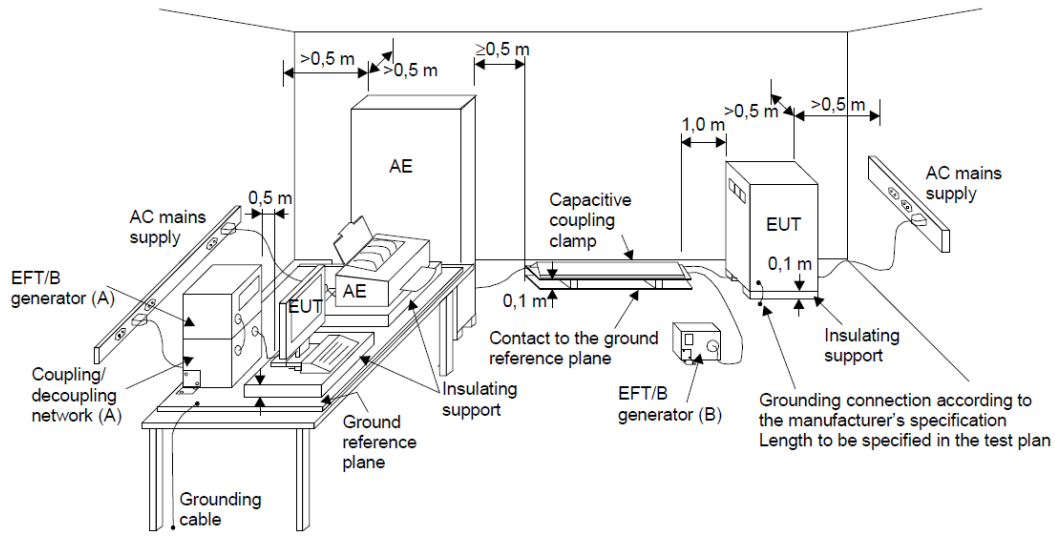

- (A) location for supply line coupling
- (B) location for signal lines coupling

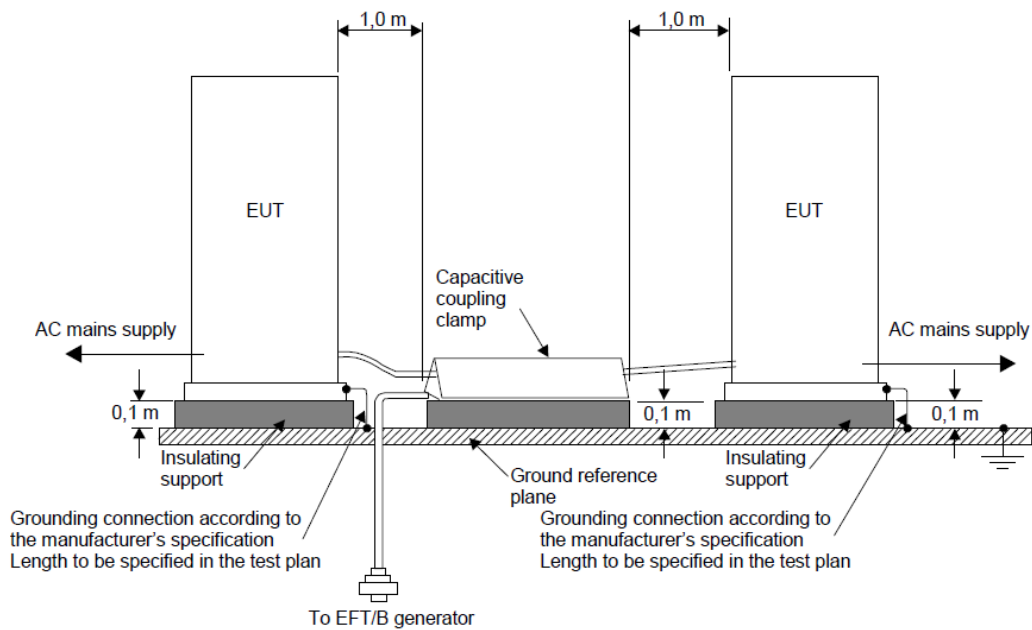



5.5.6 Test Result

Test Voltage	230Vac, 50Hz	Environmental Conditions	22°C, 50% RH
Tested by	Alan Chung	Test Date	2024/05/31

Test Point	Test Level (kV)	Polarity (+/-)	Result
AC Power Port	L	+/-	A
	N	+/-	A
	PE	+/-	A
	L + N	+/-	A
	L + PE	+/-	A
	N + PE	+/-	A
	L + N + PE	+/-	A
Signal and communication, process measurement and control ports	RJ45	+/-	A
	PoE	+/-	A

Note:

Criteria A: The EUT function was correct during the test.

5.5.7 Photographs of Test Configuration

Power



Signal



PoE



5.6 Surge Immunity Test

5.6.1 Test Specification

Standard	EN 61000-4-5
Wave- Shape	1.2/50 μ s Open Circuit Voltage 8/20 μ s Short Circuit Current
Test Voltage	Power Port: line to line \pm 1kV, 42 Ω , 0.5 μ F line to ground \pm 2kV, 42 Ω , 0.5 μ F
Surge Input / Output	L1-L2, L1-PE, L2-PE
Polarity	Positive/Negative
Phase Angle	0°/90°/180°/270° (For AC Power Port)
Pulse Repetition Rate	1 time / min. (maximum)
Times	5 positive and 5 negative at selected points

5.6.2 Test Instrument

Item	Equipment	Manufacturer	Model	Meter No.	Calibration Date
1	Surge Generator	HAEFELY	AXOS8	CT-1-059(1)	Aug. 07, 2023
2	Surge CDN	3cTest	CDN-405T8A1	CT-1-074(5)	May 27, 2024

Note: 1. The calibration interval of the above test instruments is 12 months.

5.6.3 Test Procedure

The EUT is placed on a table that is 0.8 meter above a metal ground plane measured 1m × 1m minimum and 0.65mm thick minimum and projected beyond the EUT by at least 0.1m on all sides. The length of power cord between the coupling device and the EUT shall be 2m or less.

For input power ports:

The EUT is connected to the power mains through a coupling device that directly couples the surge interference signal.

The surge noise shall be applied synchronized to the peak value of the voltage wave. (Positive and negative)

Each of Line to Earth and Line to Line is impressed with a sequence of five surge voltages with interval of 1 minute.

5.6.4 Deviation from Test Standard

No deviation

5.6.5 Test Setup

< Table-Top equipment >

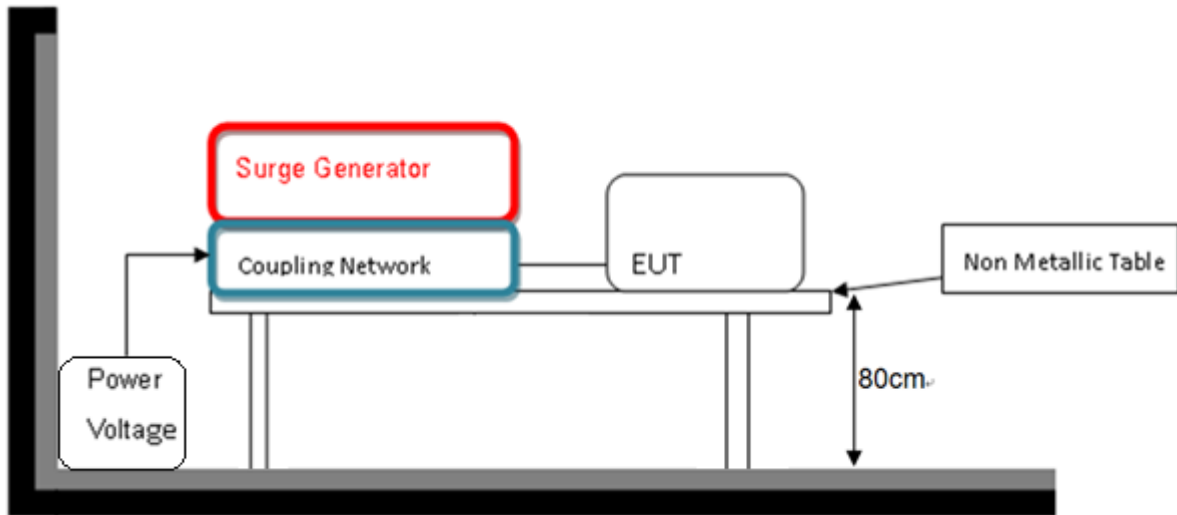

< Floor-Standing equipment >

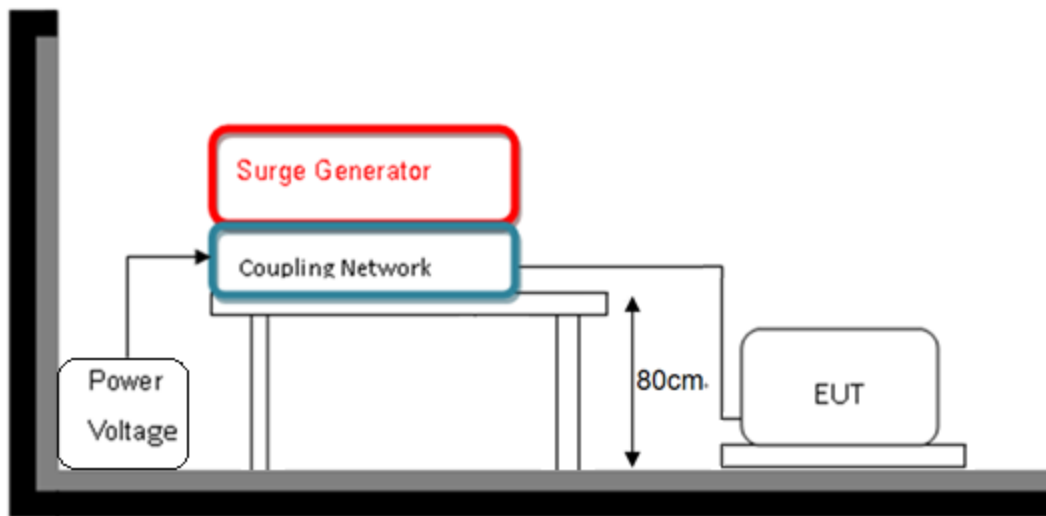



5.6.6 Test Result

Test Voltage	230Vac, 50Hz	Environmental Conditions	22°C, 54% RH
Tested by	Guanwei Liao	Test Date	2024/07/10

AC Power Port						
Test Point	Phase	Polarity (+/-)	Test Voltage (kV)			Result
			0.5	1	2	
L to N	0°	+/-	A	A	-	A
	90°	+/-	A	A	-	
	180°	+/-	A	A	-	
	270°	+/-	A	A	-	
L to PE	0°	+/-	A	A	A	A
	90°	+/-	A	A	A	
	180°	+/-	A	A	A	
	270°	+/-	A	A	A	
N to PE	0°	+/-	A	A	A	A
	90°	+/-	A	A	A	
	180°	+/-	A	A	A	
	270°	+/-	A	A	A	

Note:

Criteria A: The EUT function was correct during the test.

5.6.7 Photographs of Test Configuration



5.7 Radio-frequency common mode (CS)

5.7.1 Test Specification

Standard	EN 61000-4-6
Frequency Range	0.15MHz - 80MHz
Voltage Level	10 V(rms)
Modulation	AM Modulation, 80%, 1 kHz Sine Wave
Frequency Step	1% of fundamental
Dwell Time	3 seconds

5.7.2 Test Instrument

Item	Equipment	Manufacturer	Model	Meter No.	Calibration Date
1	Coupling clamp according to IEC 6100-4-6	FRANKONIA	EMCL-20	CT-1-049	May 30, 2024
2	CDN for power supply lines	FRANKONIA	CDN M2+M3	CT-1-054	May 30, 2024
3	6 dB Attenuator	BIRD	75-A-FFN-06	CT-1-056	May 30, 2024
4	Compact Immunity Test System acc	FRANKONIA	CIT-10/75	CT-1-057	May 30, 2024
5	CDN for screened lines	FRANKONIA	RJ45S	CT-1-052 (1)	May 30, 2024
6	50ohm Termination	N/A	N/A	CT-1-065-1	May 30, 2024
7	CDN Four Balanced Pairs-unscreened	Com-Power	CDN-T8E	CT-1-130	May 30, 2024
8	Measurement Software	HUBERT	Ver: 1.1.2	N/A	No calibration request

Note: 1. The calibration interval of the above test instruments is 12 months.

5.7.3 Test Procedure

The EUT is placed on 0.1m insulation table between the EUT and ground reference plane.

For input power ports:

The EUT is connected to the power ports through a coupling and decoupling networks for power supply lines. And directly couples the disturbances signal into EUT.

Auxiliary equipment (AE) required for the defined operation of the EUT according to the specifications of the product committee.

5.7.4 Deviation from Test Standard

No deviation

5.7.5 Test Setup

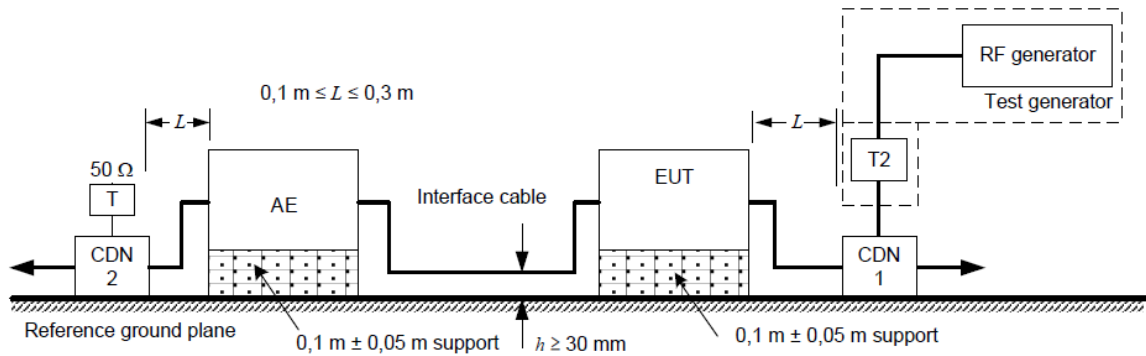

The interface cable is set at 1 m if possible.

a) Schematic setup for a 2-port EUT connected to only 1 CDN

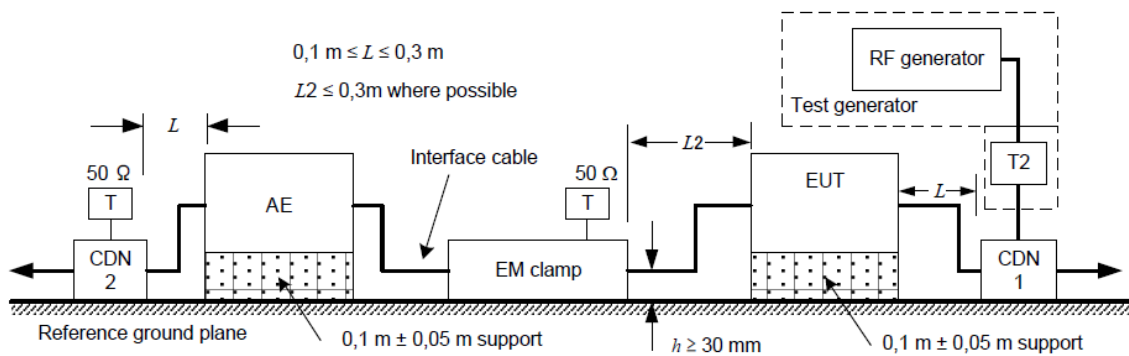

Note:

T: Termination 50 Ω

T2: Power attenuator (6 dB)

CDN: Coupling and decoupling network

Injection clamp: current clamp or EM clamp



5.7.6 Test Result

Test Voltage	230Vac, 50Hz	Environmental Conditions	24°C, 50% RH
Tested by	Dennis Chen	Test Date	2024/06/24

Frequency Range (MHz)	Tested Port	Injection Method	Test Level (V_{r.m.s.})	Modulation	Result
0.15 - 80	AC Power	CDN-M2 +M3(M3)	10	80% AM, 1kHz	A
0.15 - 80	RJ45	RJ45S	10	80% AM, 1kHz	A
0.15 - 80	PoE	RJ45S	10	80% AM, 1kHz	A

Note:

Criteria A: The EUT function was correct during the test.

5.7.7 Photographs of Test Configuration

Power

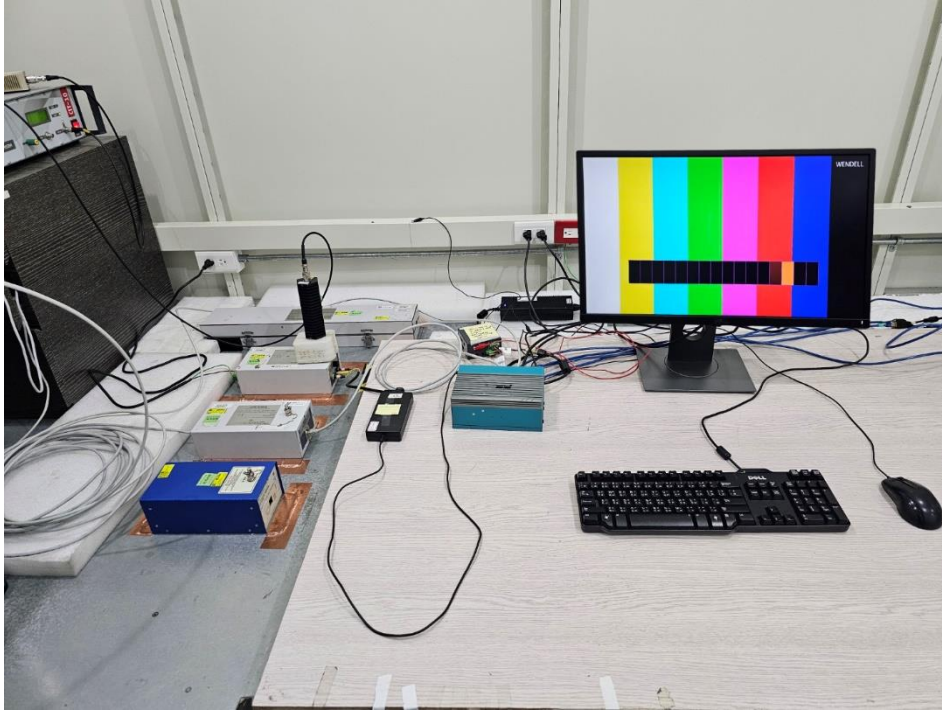

Signal

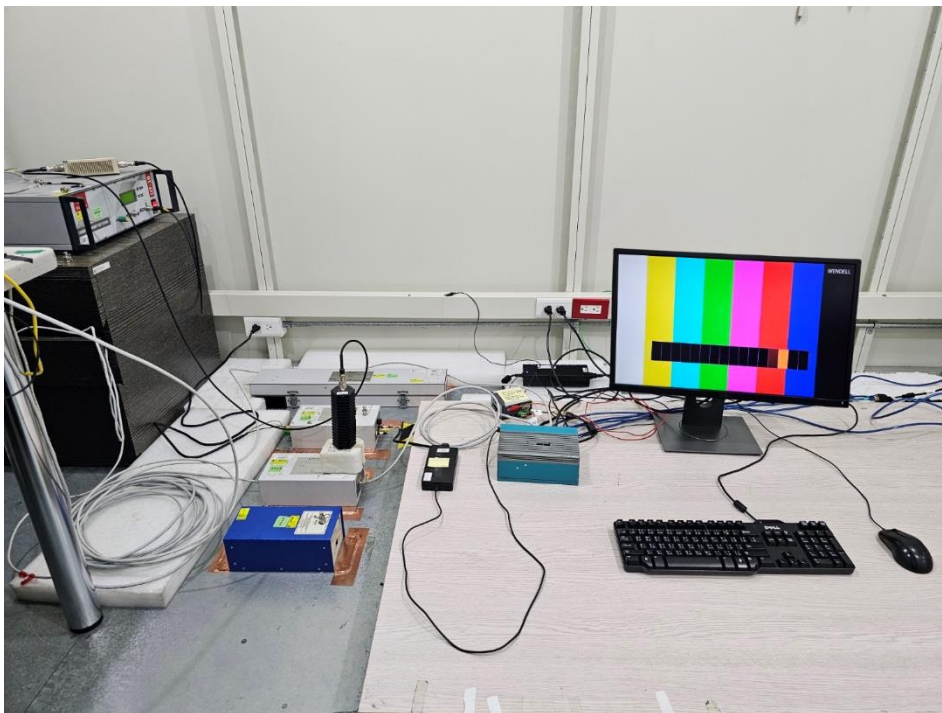

PoE

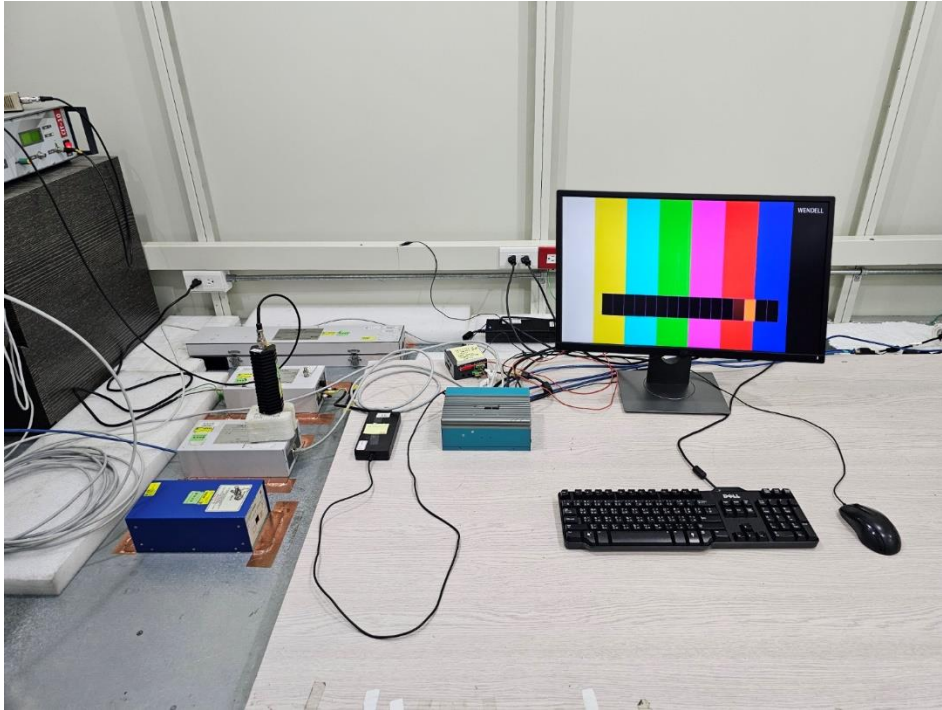

< End Page >